

Panasonic®

Digital Device Display Operating Instructions

Models No. **PT-43LCX64/PT-50LCX64/PT-60LCX64**



HDTV
— INTEGRATED TUNER —

DOLBY
DIGITAL



MultiMediaCard™

HDMI™
HIGH DEFINITION MULTIMEDIA INTERFACE

(USA)

For assistance, please call :
1-888-VIEW PTV(843-9788)
or, contact us via the web at:
<http://www.panasonic.com/contactinfo>

(Puerto Rico)

For assistance, please call :
787-750-4300
or visit us at www.panasonicpr.com

Three Important Reasons to Register Your Product Immediately!

- 1 Protect Your New Investment...**
Register your new Device Display for insurance purposes in case your new Device Display is stolen.
- 2 Product safety notification...**
Registering your product can help us to contact you in the unlikely event a safety notification is required under the Consumer Product Safety Act.
- 3 Improved Product Development...**
Help us continue to design products that meet your needs.
Register online at www.panasonic.com/register



* The presence of the DTV certification mark indicates that this product will successfully receive digital television transmissions that conform to any and all of the video formats described in the ATSC Digital Television Standard.

This operating instruction book is designed for use with models PT-43LCX64, PT-50LCX64 and PT-60LCX64. Illustrations in this manual show the PT-50LCX64.

Before connecting, operating or adjusting this product, please read the instructions completely. Please keep this manual for future reference.



IMPORTANT SAFETY INSTRUCTIONS



CAUTION

**RISK OF ELECTRIC SHOCK
DO NOT OPEN**



WARNING: To reduce the risk of electric shock, do not remove cover or back. No user-serviceable parts inside. Refer servicing to qualified service personnel.



This symbol warns the user that uninsulated voltage within the unit may have sufficient magnitude to cause electric shock. Therefore, it is dangerous to make any kind of contact with any inside part of this unit.



This symbol alerts the user that important literature concerning the operation and maintenance of this unit has been included. Therefore, it should be read carefully in order to avoid any problems.



The pictorial representation of a hot surface within a triangle is intended to tell the user that parts inside the product are a risk of burns to persons.

Note to CATV System Installer:

This reminder is provided to call the CATV system installer's attention to Article 820-40 of the NEC that provides guidelines for proper grounding and, in particular, specifies that the cable ground shall be connected to the grounding system of the building, as close to the point of cable entry as practical.



WARNING

To reduce the risk of electric shock, fire, injury to persons or damage to this product:

- 1) **Read all instructions** before using, connecting or adjusting this product.
- 2) **Retain these safety and operating instructions** for future reference.
- 3) **Adhere to all warnings** on the product and in this Operating Instructions manual.
- 4) **Follow all instructions** carefully.
- 5) **Do not use this product near water**, for example, near a bathtub, wash bowl, kitchen sink, or laundry tub, in a wet basement or near a swimming pool, and the like. **Do not** place objects filled with water, such as a vase or the like, on top of this unit.
- 6) **Clean only with a dry cloth.** Do not use liquid cleaners or aerosol cleaners.
- 7) **Do not block any ventilation openings.** Install only in accordance with the manufacturer's instructions. Openings in the cabinet are provided for ventilation, to ensure reliable operation and to protect it from overheating. Never block openings by placing the product on a bed, sofa or similar surfaces.
- 8) **Do not install near a heat source**, such as a radiator, heat register, stove, or similar appliances (including amplifiers). **Do not** install in a built-in installation such as a bookcase or rack, unless proper ventilation is provided or the manufacturer's instructions have been adhered to.
- 9) **Insert plug in outlet fully - Do not defeat the safety purpose of the polarized or grounding-type plug.** A polarized plug has two blades, one wider than the other. A grounding type plug has two blades and a grounding prong. The wide blade or grounding prong is provided for your safety. If the provided plug does not fit into your outlet, consult a qualified electrician to replace the obsolete outlet.
- 10) **Protect the power cord** from being walked on, tripped over, pinched or entangled.
- 11) **Use only attachments or accessories specified by the manufacturer.**
- 12) **Never place unit on support or stand that is not firm, level, and adequately strong.** The unit could fall causing serious injury to a child or adult and damage to the unit.
 - Move any appliance and cart combination with care. Quick stops, excessive force, and uneven surfaces may cause objects to overturn.
 - Carefully follow all instructions.
- 13) **Unplug this product during lightning storms** or when unused for long periods of time.
- 14) Do not service this unit yourself. Refer all servicing to qualified personnel. Servicing is required when this product has been damaged in any way, such as if the power cord is damaged, liquid was spilled or objects were dropped into this unit, or the unit was exposed to rain or moisture, does not operate normally, or has been dropped.
- 15) Because the temperature of the lamp unit is elevated immediately after its use, a direct touch to it may cause burns. Replace the lamp unit only after it has cooled.



IMPORTANT SAFETY INSTRUCTIONS (CONTINUED)

WARNING

AS WITH ANY SMALL OBJECT, SD CARDS CAN BE SWALLOWED BY YOUNG CHILDREN. DO NOT ALLOW CHILDREN TO HANDLE THE SD CARD.

CAUTION

- (1) This Device Display is intended to be used with the following TV stand: model TY-43LC14C for the PT 43LCX64, TY-50LC14C for the PT-50LCX64, and TY60LC14C for the PT-60LCX64. Use with other stands may result in the Device Display becoming unstable, possibly causing injury.
- (2) This Device Display should not be exposed to direct sunlight, extreme temperatures or moisture, as this can result in serious irreparable damage.
- (3) This product has a High Intensity Discharge (HID) lamp that contains a small amount of mercury. It also contains lead in some components.
Disposal of these materials may be regulated in your community due to environmental considerations. For disposal or recycling information please contact your local authorities, or the Electronics Industries Alliance: <<http://www.eiae.org>.>

The lamp has a maximum life of about 10 000 hours.
If use exceeds this figure, the possibility of lamp damage becomes greater.
The lamp should be changed as soon as possible once the lamp warning message appears.
If the lamp is damaged, please contact your nearest dealer.

Due to the characteristics and use conditions of individual lamps, the lamp may cease to light before the stated lamp life.
Influences of frequent lighting, continuous light use for over 24 hours, the number of times lit, the length of time between lightings, etc. may shorten lamp life.
(Because of this, we recommend having a replacement lamp on hand.)

Trademarks

- VGA and XGA are trademarks of International Business Machines Corporation.
- Macintosh is a registered trademark of Apple Computer, USA.
- VESA and SVGA are trademarks of the Video Electronics Standard Association.
Even if no special notation has been made of company or product trademarks, these trademarks have been fully respected.
- Equipped with dbx®-TV Noise Reduction for true MTS reproduction. dbx®-TV Noise Reduction is required for good stereo separation and audio fidelity. dbx® is a registered trademark, and is licensed by dbx® Technology Licensing.



SD Logo is a trademark.



Manufactured under license from BBE Sound, Inc.
Licensed by BBE Sound, Inc. under USP4638258 and 4482866.
BBE and BBE symbol are registered trademarks of BBE Sound, Inc.



HDMI, the HDMI logo and High Definition Multimedia Interface are trademarks or registered trademarks of HDMI Licensing LLC.

This product incorporates copyright protection technology that is protected by U.S. patents and other intellectual property rights. Use of this copyright protection technology must be authorized by Macrovision Corporation, and is intended for home and other limited viewing uses only unless otherwise authorized by Macrovision. Reverse engineering or disassembly is prohibited.

U.S. Patents Nos. 4,631,603; 4,577,216; 4,819,098; 4,907,093; 6,381,747; and 6,516,132.

Dear Panasonic Customer

Welcome to the Panasonic family of customers. We hope that you will have many years of enjoyment from your new Device Display.

To obtain maximum benefit from your set, please read these Instructions before making any adjustments, and retain them for future reference.

Retain your purchase receipt also, and record the serial number of your set in the space provided on the rear cover of these instructions.

Visit our Panasonic Web Site for USA : www.panasonic.com

(USA)

For assistance, please call : 1-888-VIEW PTV(843-9788)
or, contact us via the web at: <http://www.panasonic.com/contactinfo>

(Puerto Rico)

For assistance, please call : 787-750-4300
or visit us at www.panasonicpr.com

FCC STATEMENT:

NOTE:

This equipment has been tested and found to comply with the limits for a Class B digital device, pursuant to Part 15 of the FCC Rules. These limits are designed to provide reasonable protection against harmful interference in a residential installation. This equipment generates, uses and can radiate radio frequency energy and, if not installed and used in accordance with the instructions, may cause harmful interference to radio communications. However, there is no guarantee that interference will not occur in a particular installation. If this equipment does cause harmful interference to radio or television reception, which can be determined by turning the equipment off and on, the user is encouraged to try to correct the interference by one or more of the following measures:

- Reorient or relocate the receiving antenna.
- Increase the separation between the equipment and receiver.
- Connect the equipment into an outlet on a circuit different from that to which the receiver is connected.
- Consult the dealer or an experienced radio / TV technician for help.

FCC CAUTION:

To assure continued compliance and prevent undesirable interference, use only the provided shielded RGB cable with 2 ferrite cores while connecting the Device Display to a computer. Any changes or modifications not expressly approved by the party responsible for compliance could void the user's authority to operate this equipment.

ANY CHANGES OR MODIFICATIONS TO THIS PTV RECEIVER NOT EXPRESSLY APPROVED BY MATSUSHITA ELECTRIC CORPORATION OF AMERICA COULD CAUSE HARMFUL INTERFERENCE, WHICH WOULD VOID THE USER'S AUTHORITY TO OPERATE THIS EQUIPMENT.



The Class II insulation symbol (square within a square) indicates that this product has been evaluated and tested to comply with Class II insulation requirements.

Declaration of Conformity

Models Number: **PT-43LCX64/PT-50LCX64/PT-60LCX64**
Trade Name: Panasonic
Responsible party: Matsushita Electric Corporation of America.
Address: One Panasonic Way Secaucus New Jersey 07094
Telephone number: 1-888-VIEW PTV(843-9788)

This device complies with Part 15 of the FCC Rules. Operation is subject to the following two conditions: (1) This device may not cause harmful interference, and (2) this device must accept any interference received, including interference that may cause undesired operation.

Table of Contents

To Start !	▲ IMPORTANT SAFETY INSTRUCTIONS	2
	Before Using	6
	Location of Controls	10
	Installation.....	14
<hr/>		
Use Now !	Power ON / OFF	26
	Basic Menu Navigation	28
	Tuning channels	30
	Device display operation	34
	ASPECT Controls	40
	Mute / Freeze / SAP	42
	Picture in Picture (PIP) Screen.....	44
	Split screen	46
Searching for the desired channel (Channel search)	48	
<hr/>		
Enjoy More !	Favorite Channel Feature	49
	Picture Adjustments.....	50
	Adjusting screen position and size	52
	Audio Adjustments.....	54
	Lock Feature	56
	Closed Caption Feature	66
	Channel Caption Feature	69
	Color Temp Feature.....	72
	Video NR (Noise Reduction) Feature.....	73
	3D Y/C Feature	74
	Setting when 480p signals are input through COMPONENT VIDEO INPUT	75
	3D I/P Feature.....	76
	Automatically changing screen size	77
	RGB IN Input Feature	78
	Sleep Timer Feature	79
	Information.....	80
	Demo Mode Feature	81
Signal Meter Feature	82	
Switching languages for display.....	83	
Cable Module Info.....	84	
About Screen	85	
Photo Viewer (SD Card/PC Card)	86	
<hr/>		
Other Information !	Replacing the lamp unit.....	91
	Remote Control Quick Reference Guide (Operating peripheral equipment)	92
	Troubleshooting	99
	Specifications	100
	Warning Indicators	101
	Cleaning	102
	Customer Services Directory	102
	Limited Warranty	103
Index	Back Cover	

Before Using

Receiver Location

This Device Display is intended to be used with an optional stand or entertainment center. Consult your dealer for available options.

Locate for comfortable viewing. Avoid placing where sunlight or other bright light (including reflections) will fall on the screen.

Use of some types of fluorescent lighting can reduce Remote Control transmitter range.

Adequate ventilation is essential to prevent internal component failure. Keep away from areas of excessive heat or moisture.

Optional External Equipment

The Video / Audio connection between components can be made with shielded video and audio cables. For best performance, video cables should utilize 75 Ω coaxial shielded cables. Cables are available from your dealer or electronic supply house.

Before you purchase any cables, be sure you know what type of output and input connectors your various components require. Also determine the length of cable you'll need.

Safety Precaution

Please take safety precautions to prevent the unit from falling over.

WARNING

The unit may tip or fall if not situated on a stable surface, if pushed or during an earthquake. Use a strong rope or chain (not included) to fasten the Device Display firmly to a strong wall support.

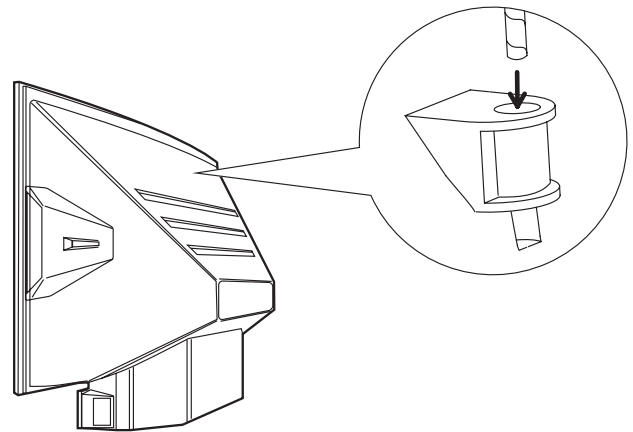

Accessories

1. Remote Control (EUR7627Z10)
2. Batteries 2 "AA"
3. RGB Cable (2 m) (LSJA0239-1 or LSJA0443)

Viewing position

To optimize your viewing comfort, please follow the viewing guidelines shown in the diagrams below. If viewing for an extended period of time, sit as far back from the screen as possible.

<Top view>

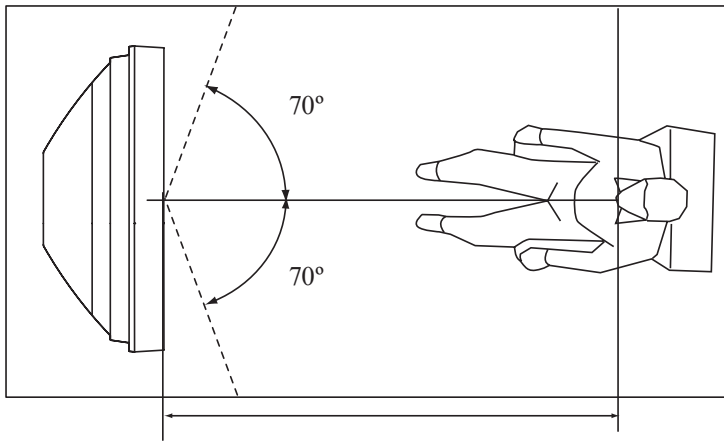

At least 1.6 m (PT-43LCX64) / 1.8 m (PT-50LCX64) / 2.2 m (PT-60LCX64).

<Side view>

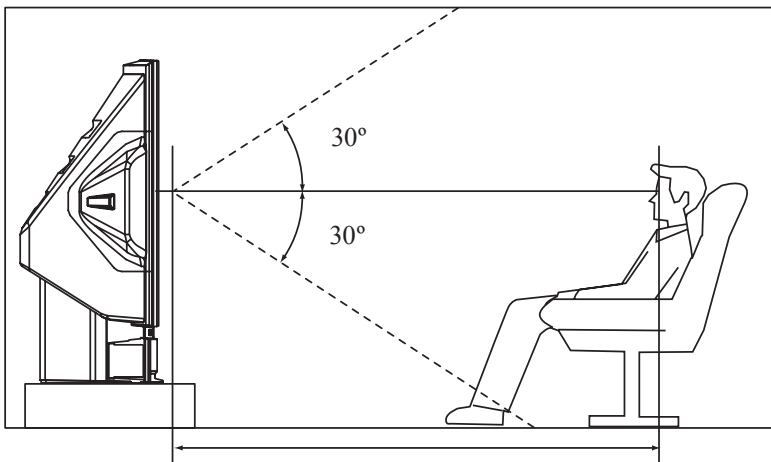

At least 1.6 m (PT-43LCX64) / 1.8 m (PT-50LCX64) / 2.2 m (PT-60LCX64).

Before Using

Remote Control Battery Installation

Requires two AA batteries (supplied).

1. While pressing in on the catch, open cover in direction of arrow.
2. Install the batteries as shown in the battery compartment. (Polarity + or - must match the markings in the compartment).
3. Press cover in direction of arrow until it snaps shut.

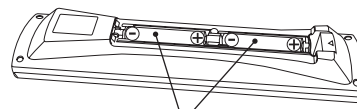
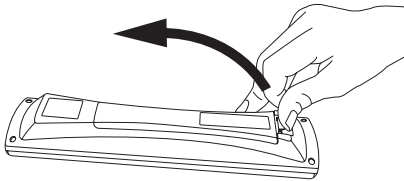

Two AA size

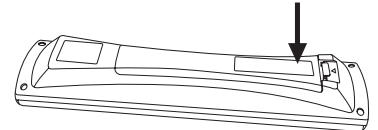

CAUTION

Incorrect battery installation can cause the batteries to leak, leading to personal injury and/or damage to the remote control.

Observe the following precautions:

1. Batteries should always be replaced as a pair. Always use new batteries when replacing the old set.
2. Do not mix battery types (example: "Zinc Carbon" with "Alkaline").
3. Do not attempt to charge, short-circuit, disassemble, heat or burn used batteries.
4. Battery replacement is necessary when the remote control acts sporadically or stops operating the Device Display set.

Helpful Hints:

- (1) For frequent remote control users, replace old batteries with Alkaline batteries for longer battery life.
- (2) Whenever you remove the batteries, **you may need to reset the remote control infrared codes.** We recommend that you record the code on page 93, prior to setting up the remote.

Emergency Alert System (EAS) Forced Tuning

If a DCM (Digital Cable Module) is installed, the cable MSO (multiple system owner/operator) may provide an Emergency Alert System message. These messages are intended to alert the general public of important local or national emergency situations. In the event of receipt of one of these messages, the Device Display shall immediately tune to the channel as directed by the EAS message. If the channel has been blocked using the parental control, the parental blocking has priority over the forced tune.

Glossary and Acronyms

CC (Closed Captioning)**EAS (Emergency Alert System)****OSD (On-Screen Display)****MSO (Multiple system owner/operator)****Dolby Digital**

This is a method of coding digital signals developed by Dolby Laboratories. Apart from stereo (2-channel) audio, these signals can also be multichannel audio. A large amount of audio information can be recorded on one disc using this method.

Film and video

DVD-Videos are recorded using either film or video. Usually, film is recorded at 24 frames per second, the rate movies are filmed at, while video is recorded at 30 frames per second.

PCM (pulse code modulation)

These are uncompressed digital signals, similar to those found on CDs.

DTV (Digital Television)

Name of the process whereby television picture and sound signals are changed to digital code for receiving and transmitting.

HDTV (High Definition Television)

Television with improved picture quality by increasing vertical and horizontal resolution.

ATSC (Advanced Television Systems Committee)

Standardization body that developed the Digital Television Terrestrial formats.

DCF (Design rule for Camera File system)

Unified standard established by Japan Electronics and Information Technology Industries Association (JEITA).

HDMI (High Definition Multimedia Interface)

Interface that supports every uncompressed digital format as well as all existing multi-channel audio format on a single cable.

JPEG (Joint Photographic Experts Group)

A system used for compressing/decoding color still pictures.

MPAA (Motion Picture Association of America)

Guild governing rating assignments to movies.

NTSC (National Television Systems Committee)

Standardization body that developed the Analog Television Terrestrial formats.

Password

A four (4) digit code a user must provide in order to perform a function.

DCM (Digital Cable Module)

A module that is required to receive premium digital services through the cable input.

Location of Controls

Illuminated Remote Control

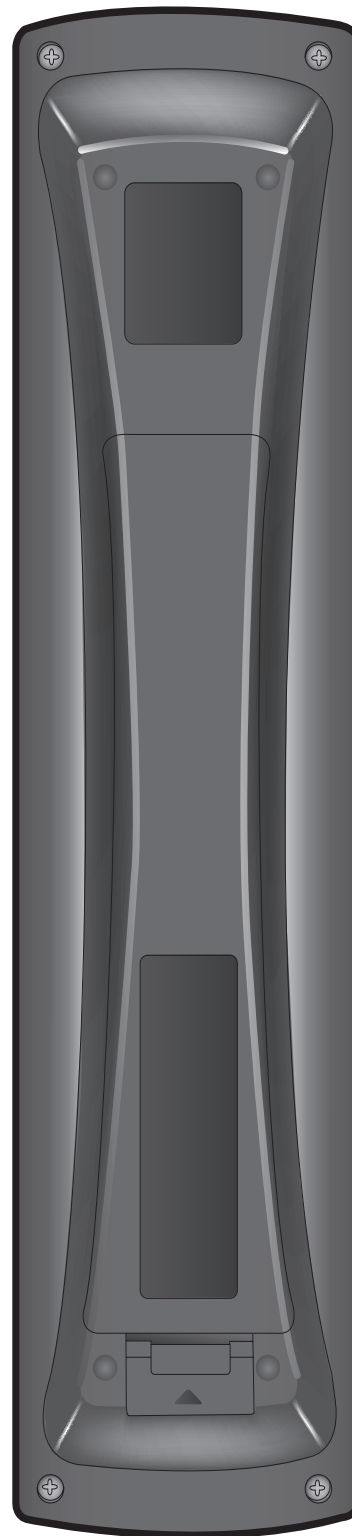
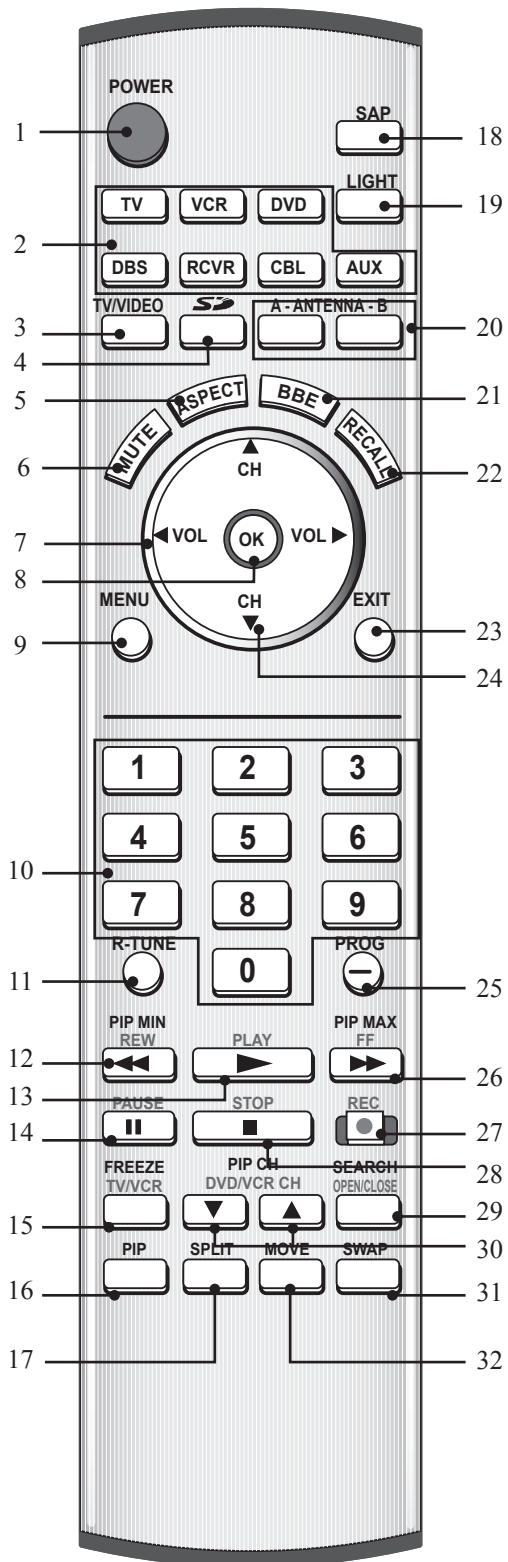

Note:

This section describes TV mode only. For other modes, see pages 92-98.

Location of Controls

	Remote Keys	DESCRIPTION
1	POWER	Press to turn ON and OFF.
2	TV	Sets the remote to communicate with television.
	VCR, DVD, AUX, CBL, RCVR, DBS	Sets the remote to communicate with other devices.
3	TV/VIDEO	Changes Input source.
4	SD	Accesses the Photo Viewer feature (SD Card or PC Card).
5	ASPECT	Changes display aspect ratio.
6	MUTE	Press to mute sound.
7	VOL ◀▶	Press to adjust TV sound and navigate in menus.
8	OK	Press to choose menu and sub-menu entry.
9	MENU	Press to display Main Menu or return one step backward in menus.
10	Number	Press numeric keypad to select any channel or press to enter alphanumeric input in menus.
11	R-TUNE	Press to switch to previously viewed channel, Photo Viewer or input modes.
12	PIP MIN	While remote is in TV mode, press to decrease the PIP size.
	REW	While remote is in VCR or DVD mode, press to rewind.
13	PLAY	While remote is in VCR or DVD mode, press to play.
14	PAUSE	While remote is in VCR or DVD mode, press to pause.
15	FREEZE	Still full video window.
	TV/VCR	Press to switch to TV or VCR.
16	PIP	Press to display or delete PIP screen.
17	SPLIT	Press to display or delete Split screen.
18	SAP	In analog mode, press to access audio modes (Stereo, SAP or Mono). In digital mode, press to access next audio track.
19	LIGHT	Lights all buttons. The selected mode button (TV, VCR, etc.) flashes.
20	ANTENNA A/B	Press to switch to (A or B) RF antenna input.
21	BBE	Press to turn BBE OFF or ON.
22	RECALL	Press to display or delete Channel banner.
23	EXIT	Press to exit menus.
24	CH ▲▼	Press to change channels and navigate in menus.
25	PROG	Press after entering major channel numbers to enter minor (-) channel numbers.
26	PIP MAX	While remote is in TV mode, press to increase the PIP size.
	FF	While remote is in VCR or DVD mode, press to fast forward.
27	REC	While remote is in VCR mode, press to record.
28	STOP	While remote is in VCR or DVD mode, press to stop.
29	SEARCH	While remote is in TV mode, press to scan available channels in search screens. Press again to delete search screens.
	OPEN/CLOSE	While remote is in DVD mode, press to open or close DVD tray.
30	PIP CH ▲▼	While remote is in TV mode, press to change channels for PIP.
	DVD/VCR CH	While remote is in VCR or DVD mode, press to change channels for DVD or VCR.
31	SWAP	Press to swap Main screen with PIP or Split screen.
32	MOVE	While PIP screen is displayed, press to move to one of four corners.

Location of Controls

Controls and Terminals on the Device Display

Model PT-50LCX64 unit shown

< FRONT >

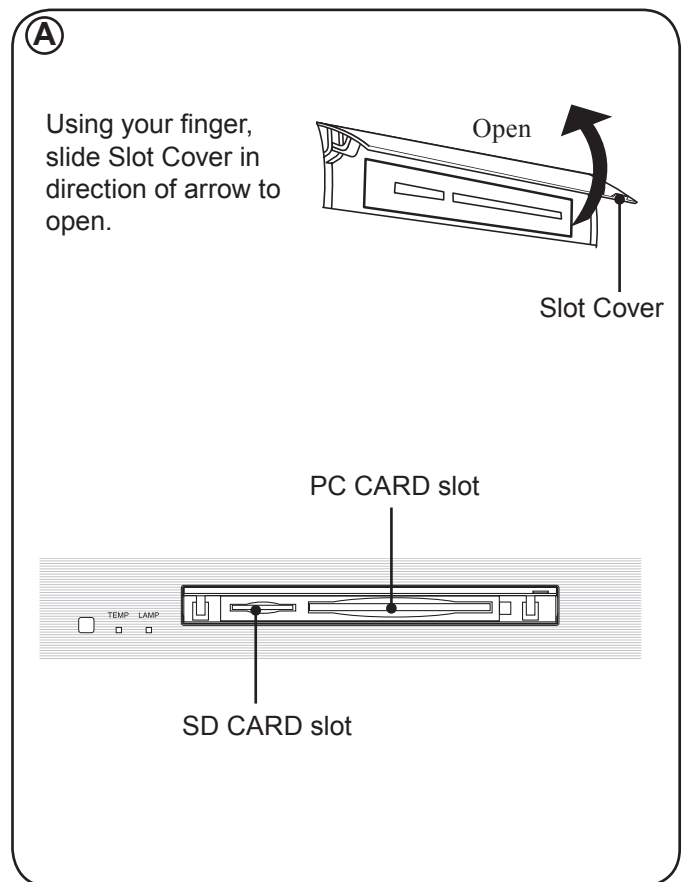
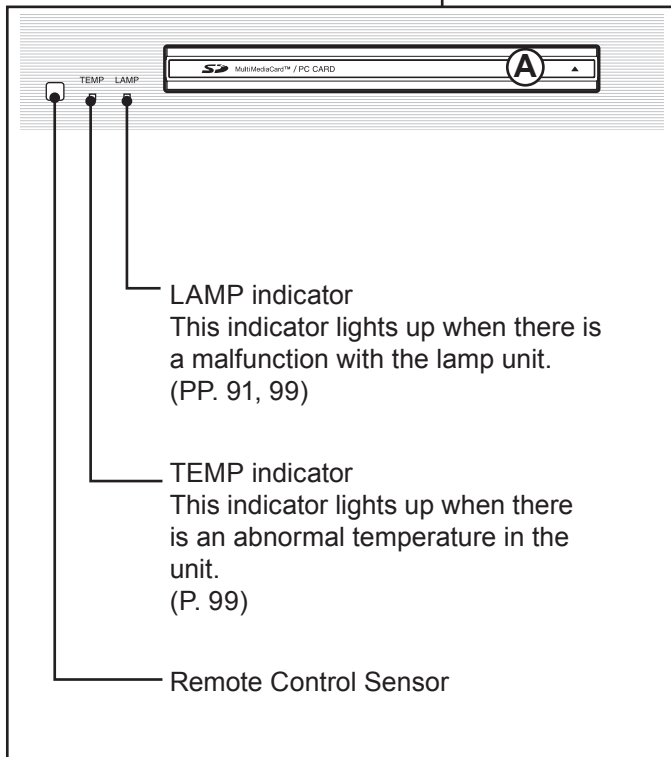
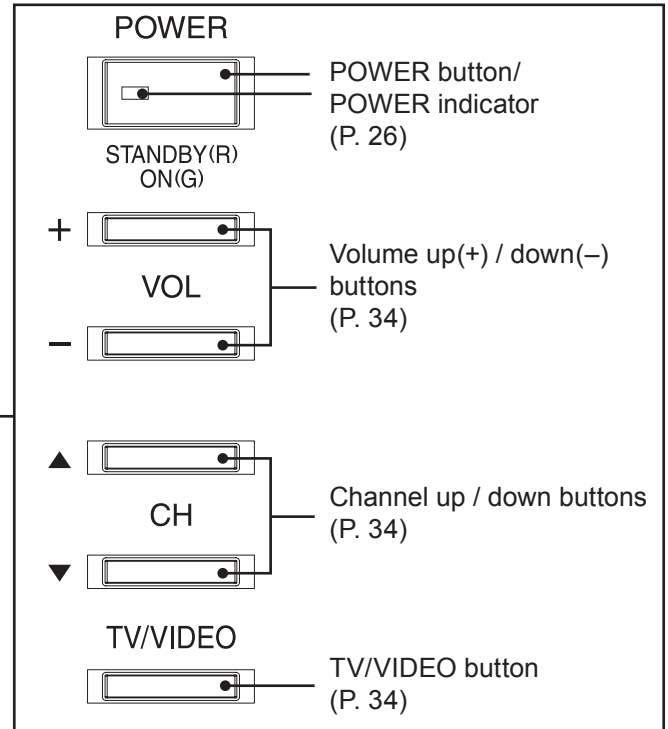
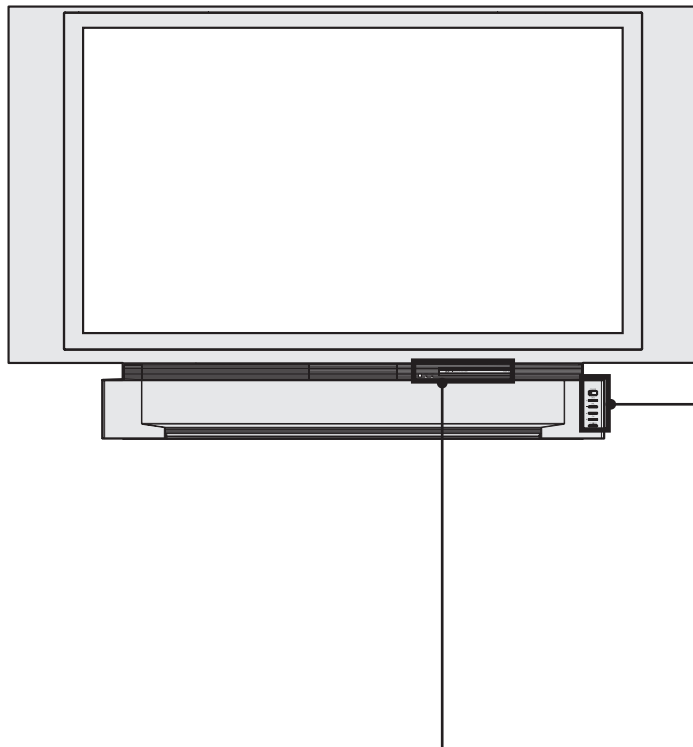

Model PT-50LCX64 unit shown

< REAR >

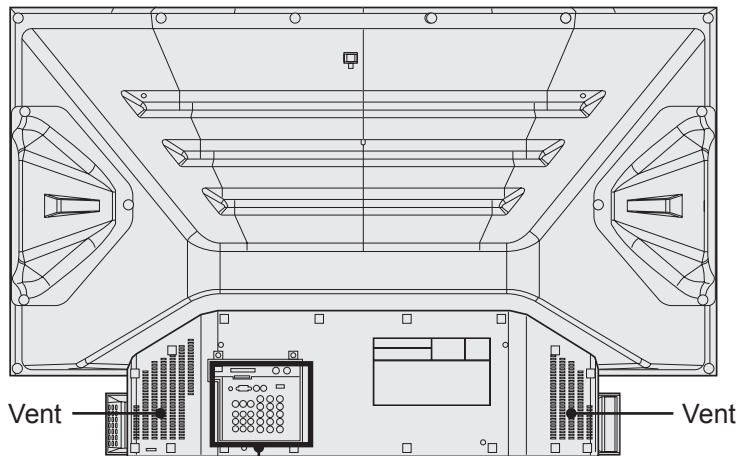

< SIDE >

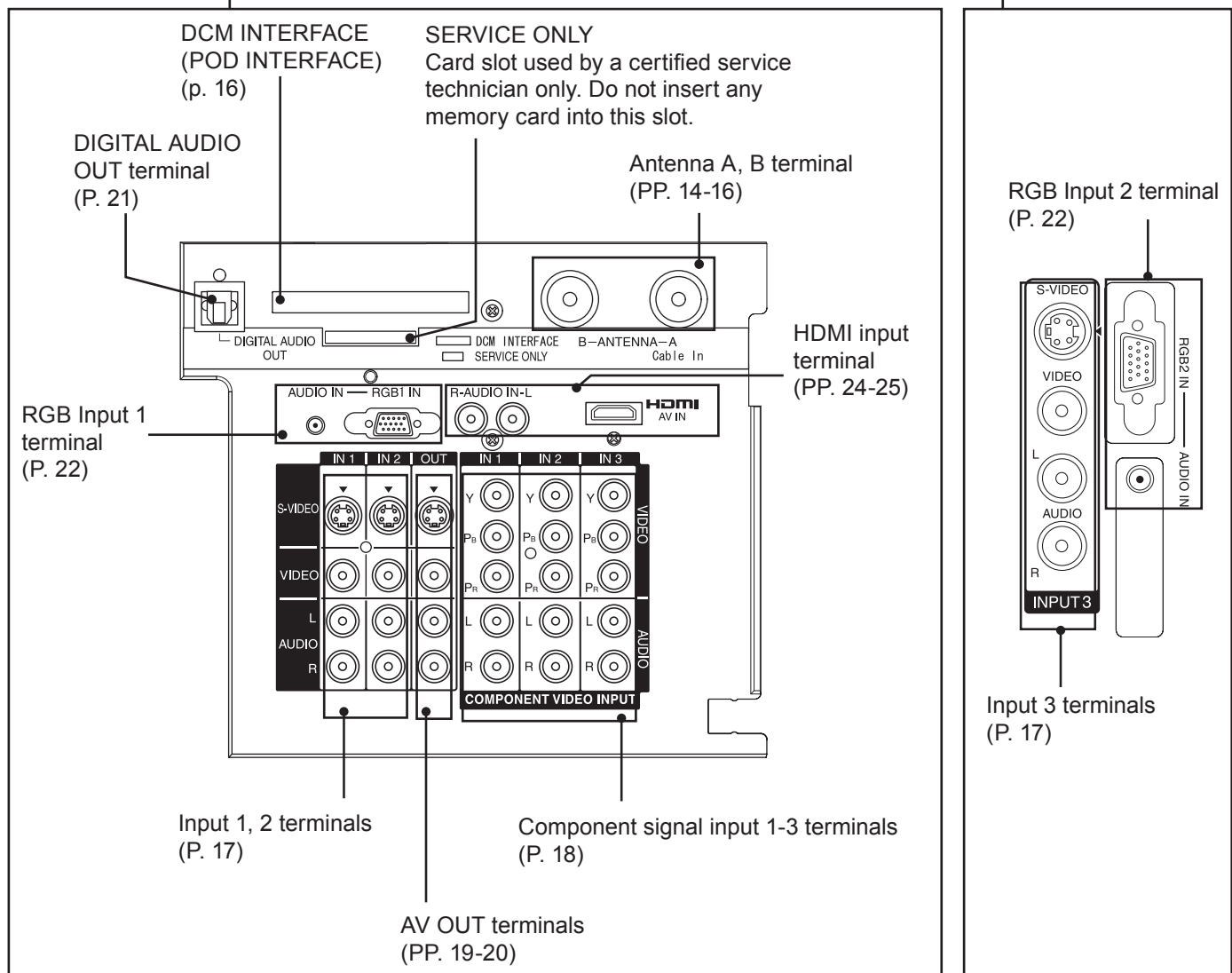
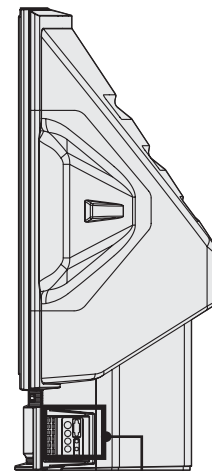

Notes:

- Make sure the vents are not blocked. (This could cause damage.)
- Indication on the back panel may change without notice.

Installation

Notes on connections

- Turn off the power supply for all components before making any connections.
- If the cables necessary for connecting a component to the system are not included with the component or available as an option, you may need to fashion a cable to suit the component concerned.
- Read the instruction manual for each system component carefully before connecting it.
- If there is a lot of jitter in the video signal input from the video source, the picture on the screen may flicker. In this case, it will be necessary to connect a TBC (time base corrector).

CAUTION

When using “Nut type” RF coaxial cables, tighten with fingers only. Overtightening may damage terminals.

Connecting the Antenna / Cable to the RF IN Terminal

For proper reception of analog or digital cable channels, a cable service connection is required.

Cable Connection

Connect the cable supplied by your local cable company to ANTENNA (A) connection on back of unit. Select Cable mode and ANTENNA (A) in SET UP menu under Program Channel.

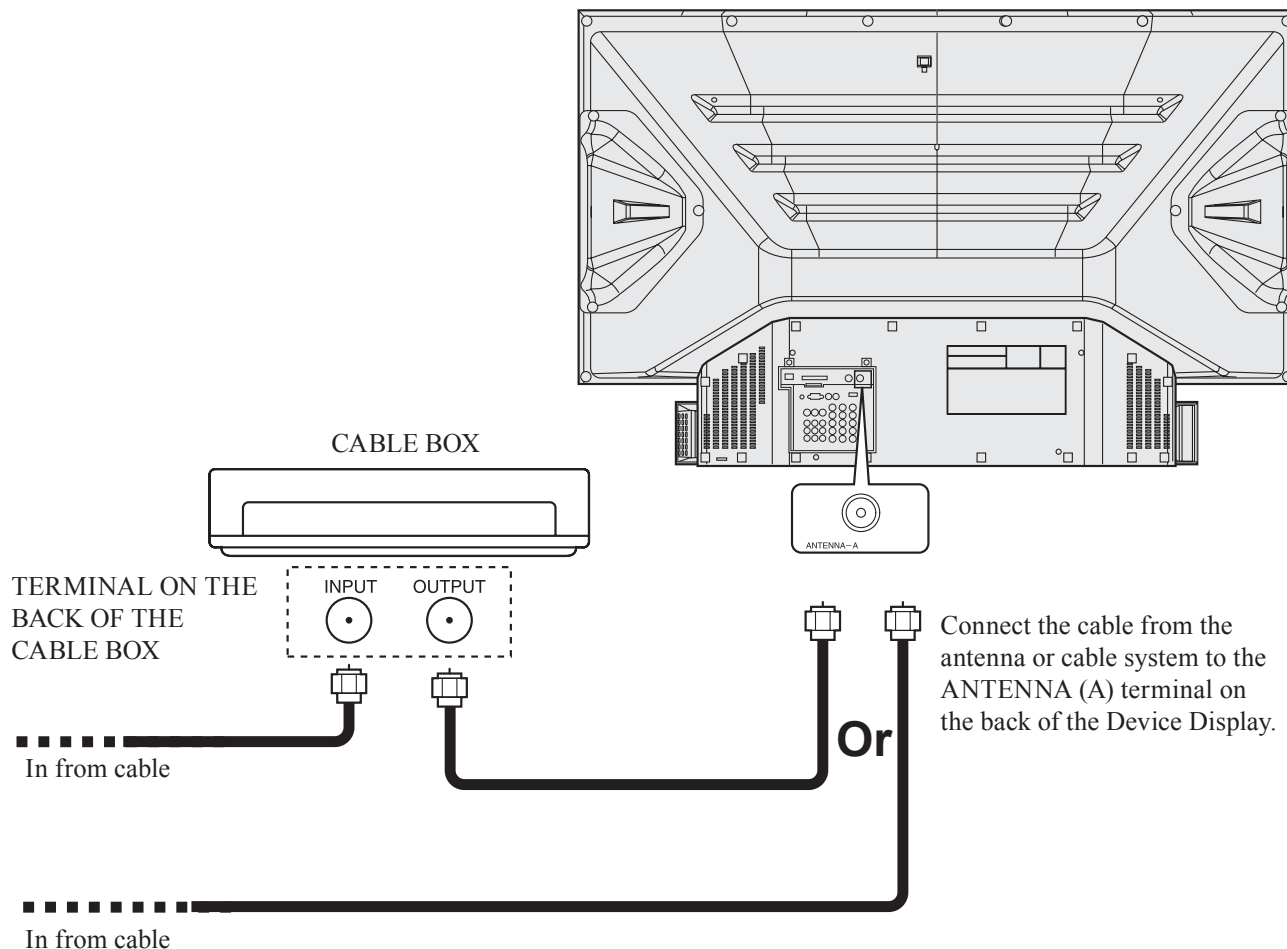

Note:

Cable Mode is preset at the factory. Antenna users must change to ANTENNA Mode for ANTENNA (A) in the Setup menu. If you have both Cable and Antenna, the Cable must be connected to ANT A.

Antenna Connection

For proper reception of digital and analog VHF/UHF channels, an external antenna is required. For best reception, an outdoor antenna is recommended.

Connect home antenna to either ANT (A) or ANT (B) connection on back of the unit. Select Antenna mode for Cable/Antenna, Cable only, Antenna only or in Input Setup under Program Channel in Setup menu.

Antenna connect only:

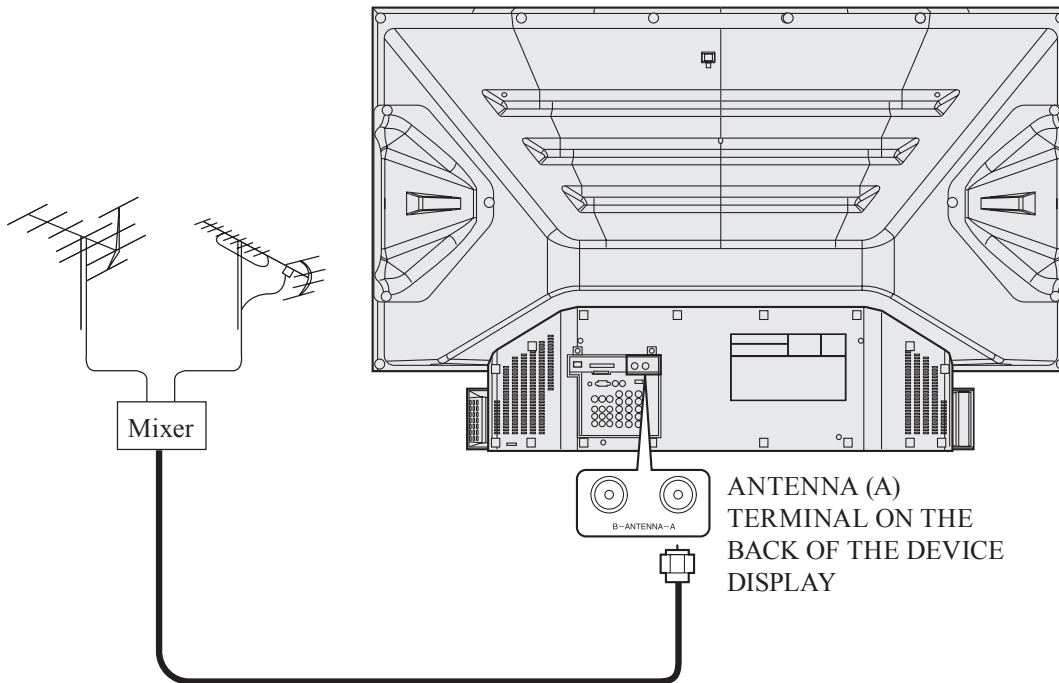

Antenna and Cable connect:

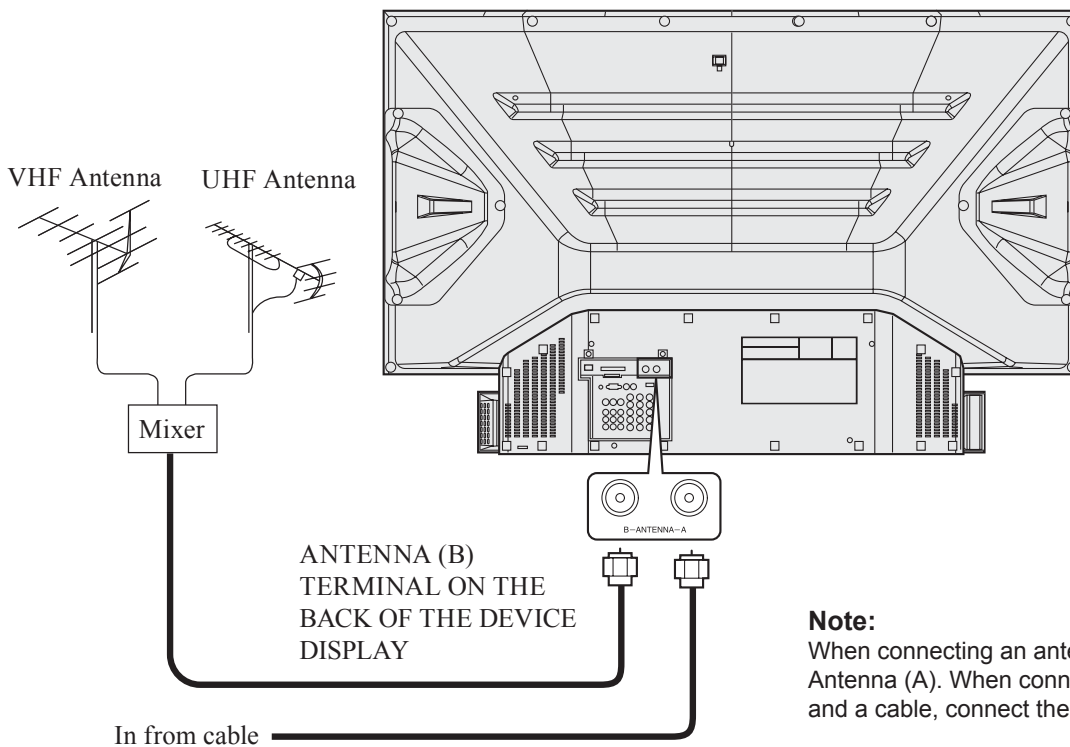

Note:

When connecting an antenna only, connect to Antenna (A). When connecting both an antenna and a cable, connect the antenna to Antenna (B).

Installation

Digital Cable Module Connection

This module allows you to tune digital and high definition cable channels through the cable antenna. Consult your Cable company on the availability of this module (also called Point of Deployment (POD) module).

- 1 Connect the Cable antenna to ANT A/Cable In input on the back of the unit.
- 2 Insert the DCM (Digital Cable Module) (upper side facing left) into the DCM INTERFACE (POD INTERFACE) slot on the back of the unit.

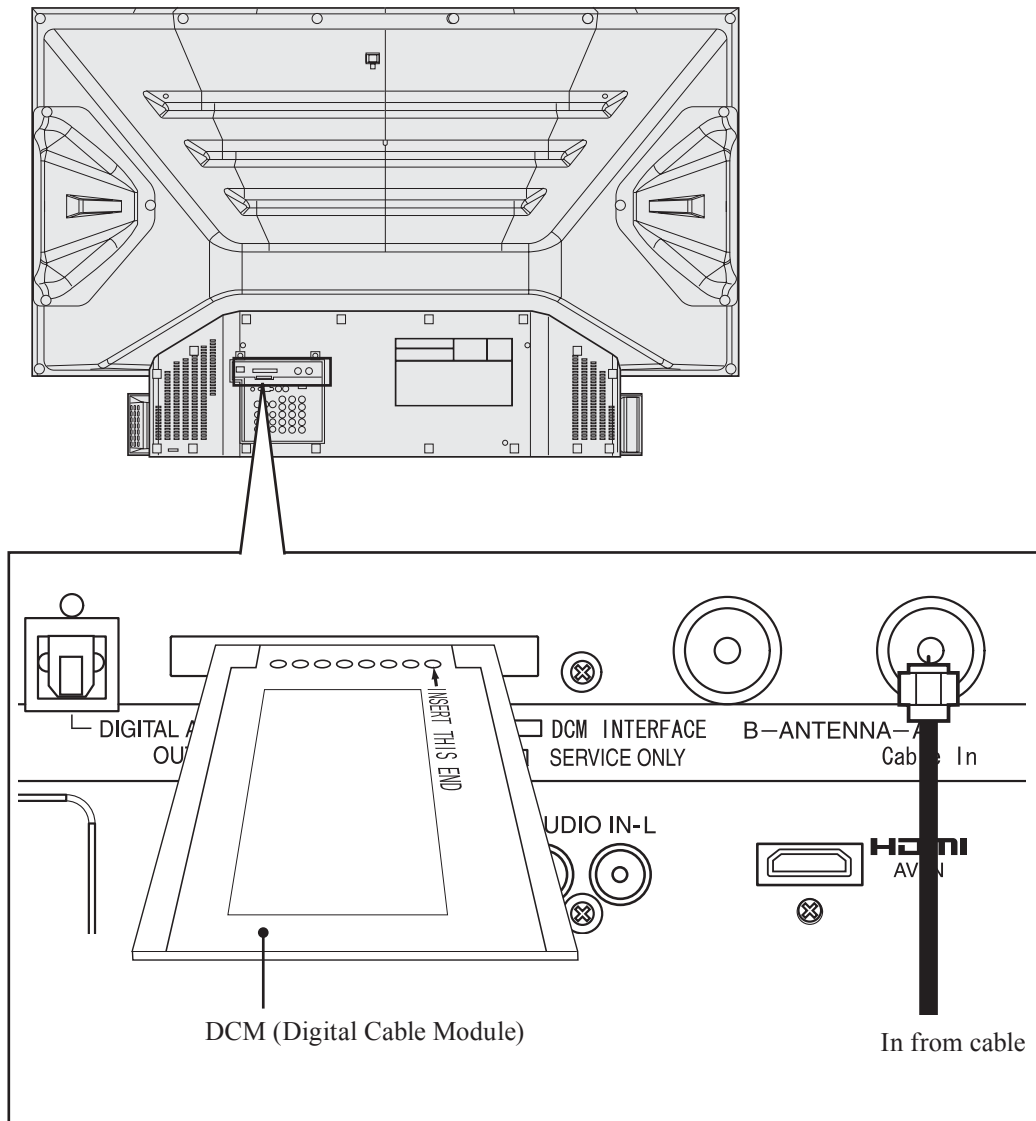

Notes:

- A Digital Cable Subscription is required. (See page 84)
- Do not insert a PC card into the DCM INTERFACE (POD INTERFACE).
- Choose Cable mode for Antenna (A) in Input Setup.
- Follow the instructions on screen.

If you experience keyboard or remote control function hang-up when using DCM (Digital Cable Module), unplug the unit and plug it back on and try the controls again. If this condition still exists, please call Panasonic Customer Call Center for further instructions.

How to connect the “1, 2, 3” Input Terminals

Connects VCRs and other peripheral equipment

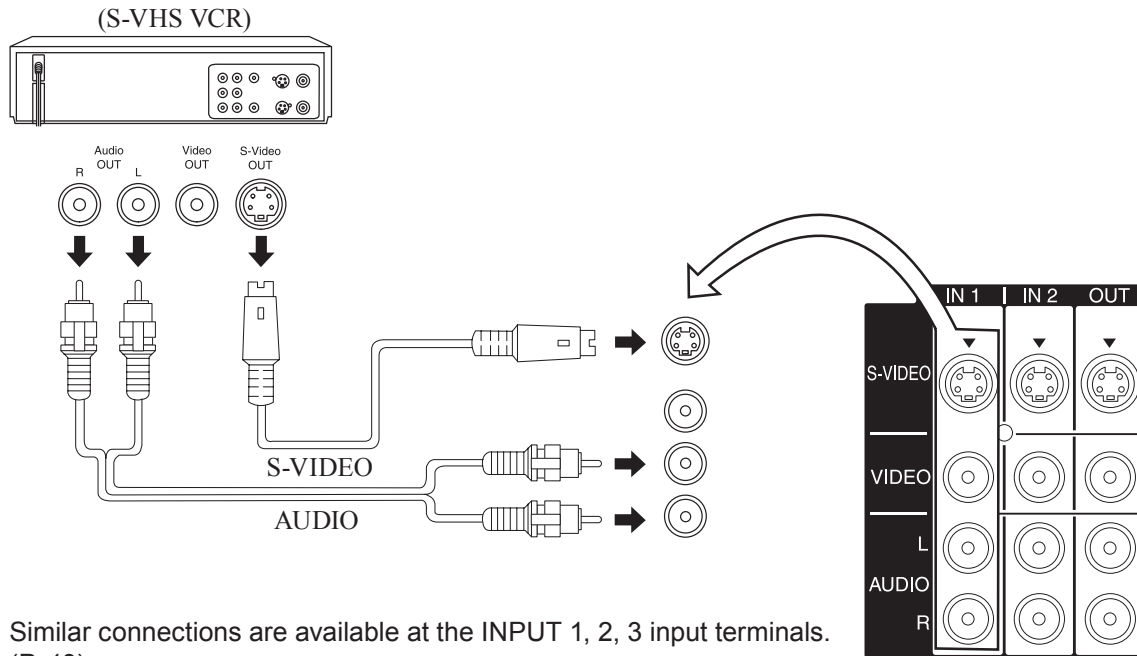

Similar connections are available at the INPUT 1, 2, 3 input terminals. (P. 13)

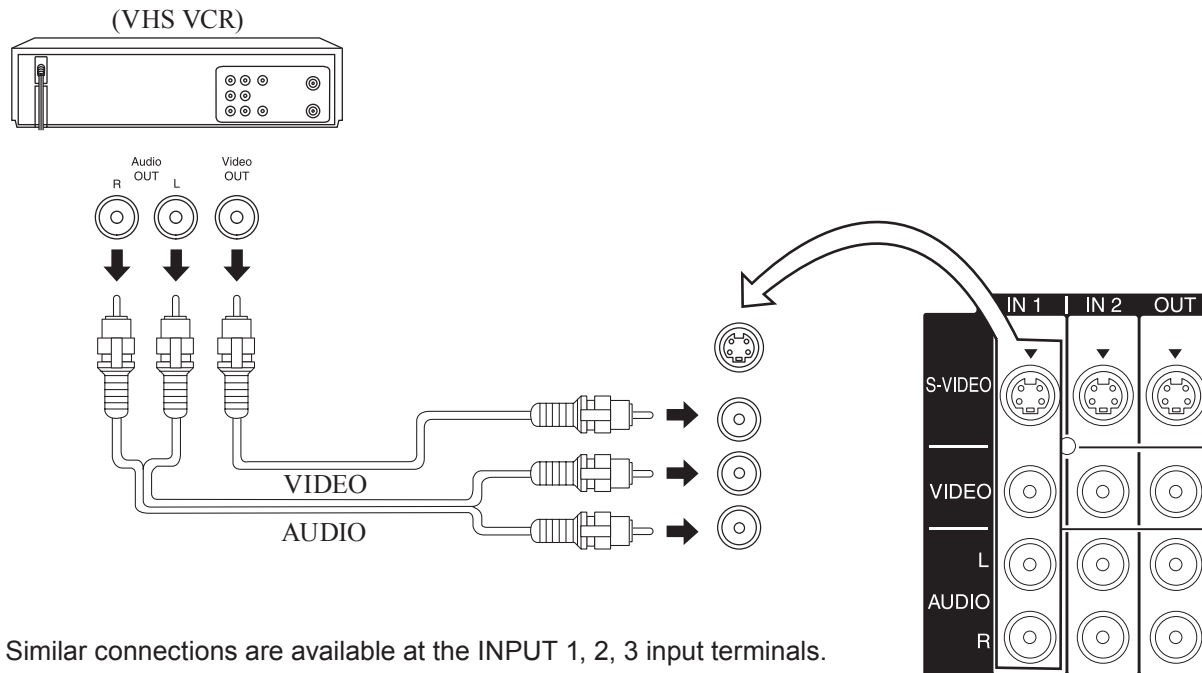

Similar connections are available at the INPUT 1, 2, 3 input terminals.

Notes:

- Input 3 is located on the side of the unit.
- Select the desired VIDEO input position by pressing the TV/VIDEO button. (P. 37)
- When connecting video cables, priority is given to the S-Video cable when the S-Video input terminal and the video input terminal are connected at the same time.

Installation

How to connect the COMPONENT VIDEO Input Terminals

Because each Y, PB, and PR signal is input independently, the Component signal allows for more accurate color reproduction.

The Component signal output terminal indication will differ according to the output device (Y, PB, PR). Please read the operating instructions included with the output device.

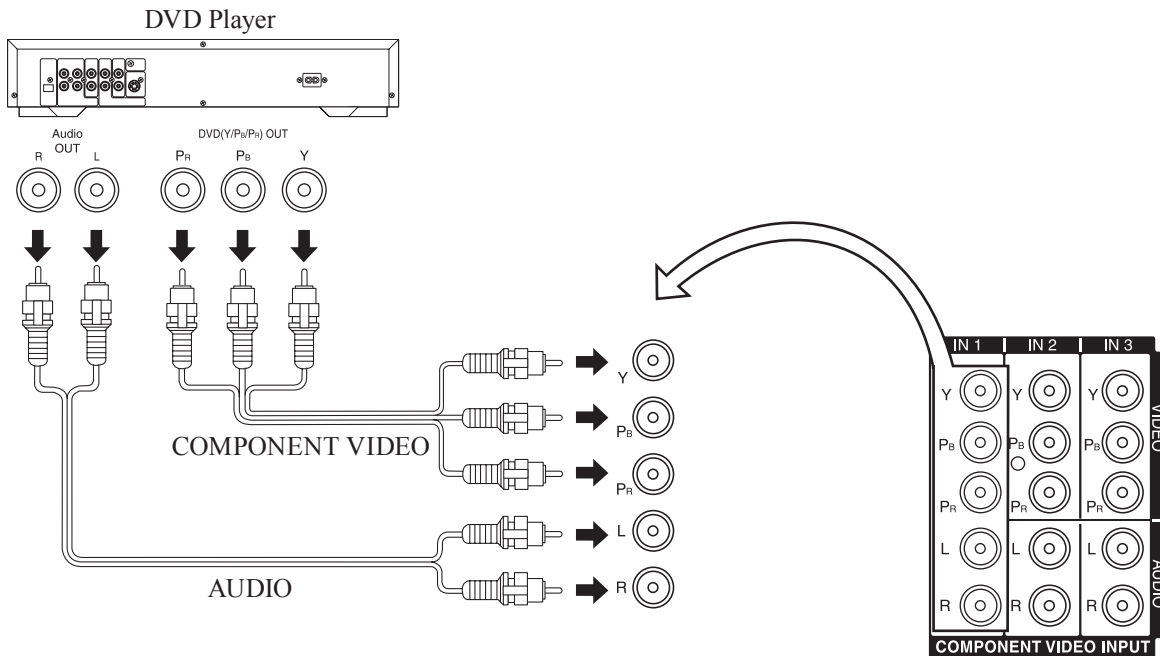

Notes:

- Similar connections are available at the COMPONENT VIDEO INPUT 1-3 Terminals.
- Select the desired COMPONENT VIDEO INPUT position by pressing the TV/VIDEO button. (P. 37)
- Component video signals that can be input are 480i, 480p, 720p, and 1080i.

Component Signals (Y, PB, PR) that can be Input

Mode type		Signal data			Information menu display
		No. of dots (H X V)	Horizontal frequency (kHz)	Vertical frequency (Hz)	
DTV Format Signals	480i	664 X 485	15.73	29.97	480 i
	480p	720 X 483	31.47	59.94	480 p
	720p	1 280 X 720	45.00	60.00	720 p
	*1080i	1 920 X 1 080	33.75	30.00	1080 i

Note:

Input signals, other than those listed with a * mark, will give you a beautiful, stable picture.

How to connect the AV OUT Terminals

You can connect a VCR to the AV OUT terminal to record the program you are viewing on-screen. An external monitor can also be connected to the AV OUT terminals. Connect the VCR as shown below.

Recording Equipment
(S-VHS /VHS VCR)

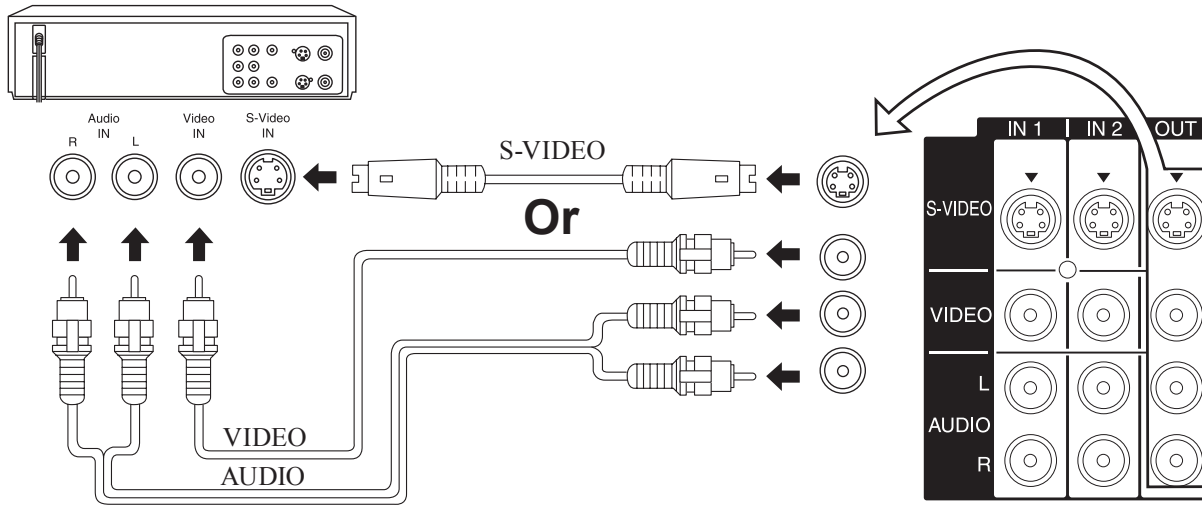

Notes:

- This unit contains Video and Audio Outputs for the purpose of recording television programming to VCR. Due to license restrictions, if a device (STB, DVD, etc.) is connected to the HDMI input of the unit, no video or audio output is allowed.
- AV Out signal is available when receiving digital channel. However, all formats will be down converted to NTSC.
- Never connect the VIDEO IN and OUT terminals to the same video recorder, as this could cause incorrect operation.
- Even if unit is in Split or PIP mode, OUT terminals only output the main picture and sound signals. A sub-picture, including channel search, etc., will not be output.
- AV terminals will not output Y, P_B, P_R, RGB/HDMI IN or SD/PC card signals.
- The S-Video OUT terminal outputs the same signal that is input from the S-Video IN terminal and Digital RF channels.
- Certain program content output from the AV Out connector may have the Macrovision signal modification applied to its signal, preventing VCRs from recording this video signal.

Installation

How to connect the Amplifier

Analog Audio Out

To listen to the audio through a separate stereo system, connect an external audio amplifier to **AUDIO OUT** on back of unit.

Stereo System
(A Stereo Amplifier and Speakers)

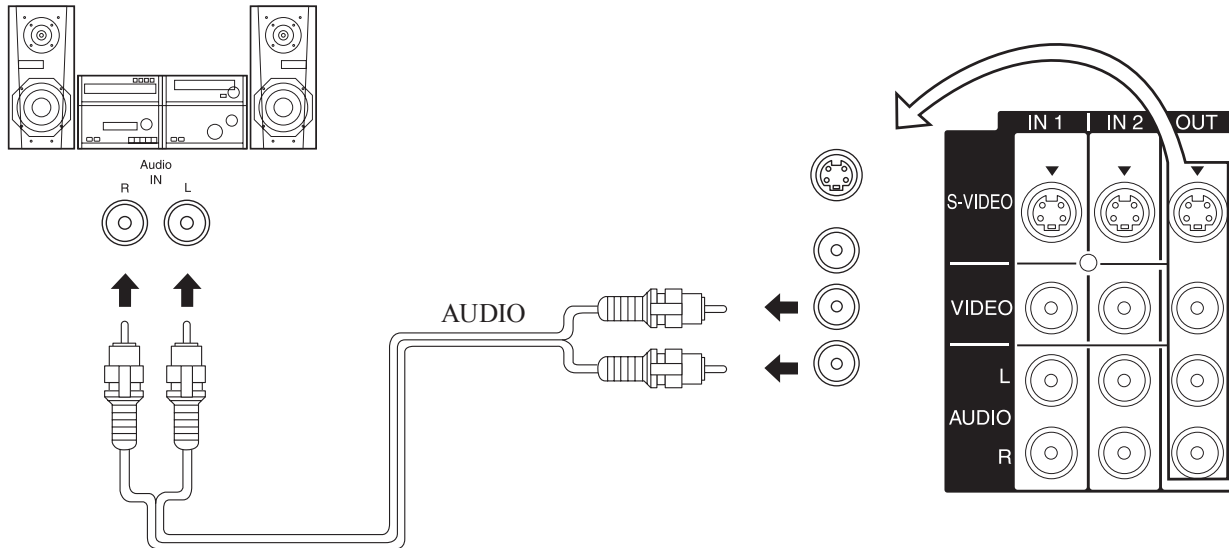

Note:

AUDIO OUT terminals cannot be connected directly to external speakers.

Audio Adjustments

- Select Speakers Off in Audio menu under Other Adjust menu.
- Set amplifier volume to the preferred level.

Digital Audio Out

Use the diagram below to connect the Digital Audio Output of your Device Display to a Dolby Digital decoder.

Dolby Digital 5.1 channel surround sound delivers digital-quality sound. Dolby Digital provides five discrete full-bandwidth channels for front left, front right, center, surround left and surround right, plus a LFE (Low Frequency Effect) subwoofer channel. For a full Home Theater sound experience, an external Dolby Digital decoder and a multichannel amplifier must be connected to the Digital Audio Out jack on the unit.

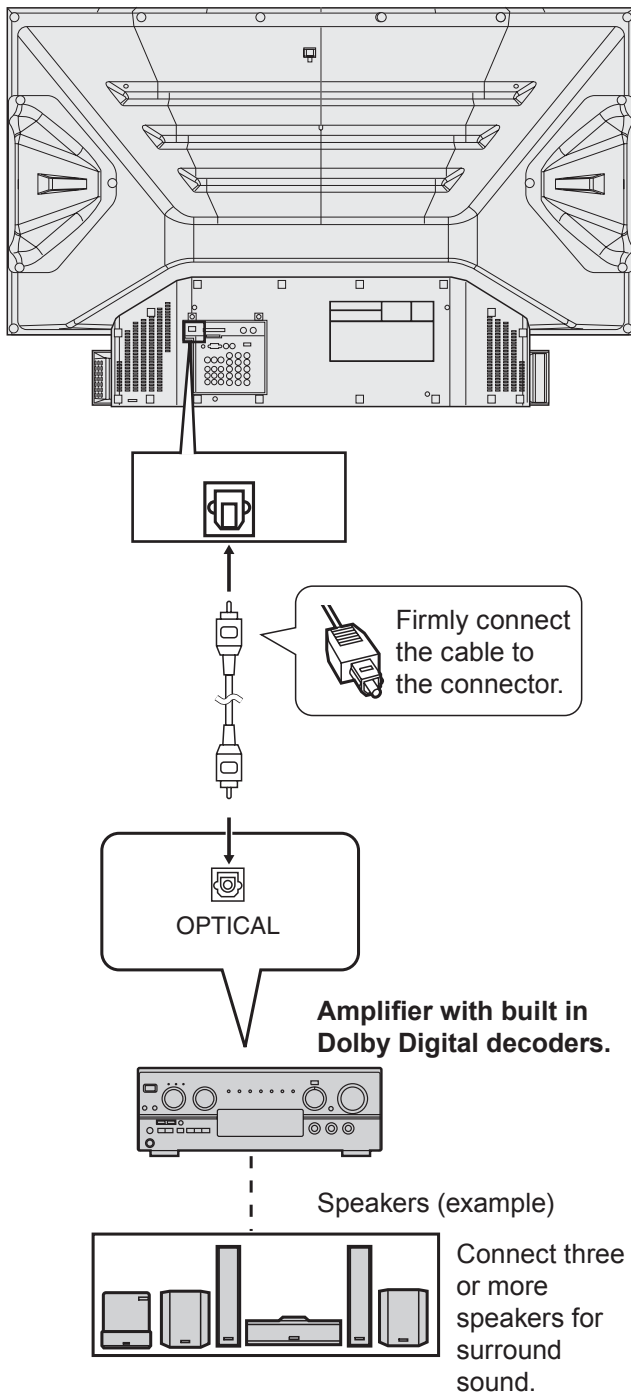

Procedure

Connect the Digital Audio cable from the Digital Audio Out jack on the unit to the Digital Audio In connection on the Dolby Digital decoder.

Note:

When ATSC channel is selected, the output from the Digital Audio Out jack will be Dolby Digital. But, if NTSC channel is selected, the output will be PCM.



Manufactured under license from Dolby Laboratories. "Dolby" and the double-D symbol are trademarks of Dolby Laboratories.

Installation

How to connect the RGB IN Terminals

Connecting a PC to RGB IN

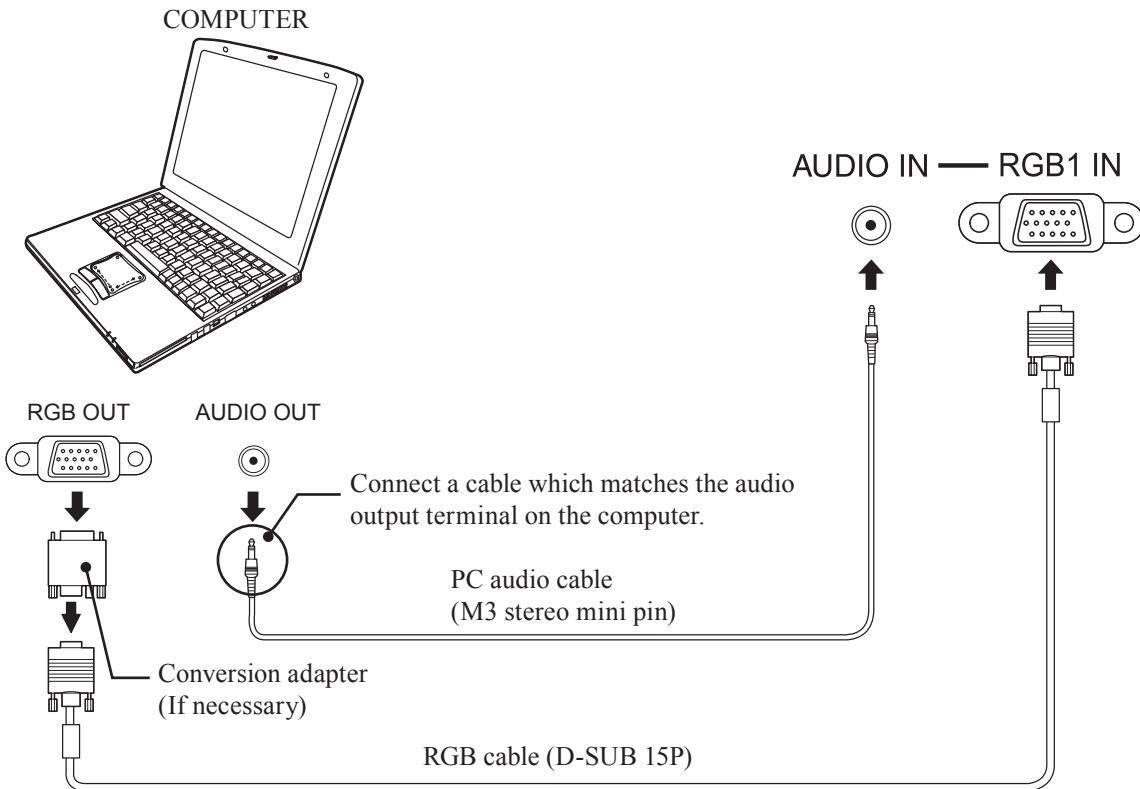

RGB IN Terminal (D-SUB 15P) Pin Layouts

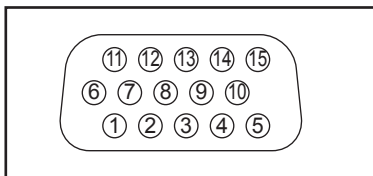

Pin No.	Signal name
1	R
2	G
3	B
4	NC
5	NC
6	Ground for R
7	Ground for G
8	Ground for B

Pin No.	Signal name
9	NC
10	Ground
11	NC
12	NC
13	HD/CSYNC
14	VD
15	NC

NC: Not connected

Notes:

- Some PC models cannot be connected to the set. A conversion adapter is required to use the RGB cable (D-SUB 15P) to connect a Macintosh computer to the set. There is no need to use an adapter for computers with PC / AT compatible D-SUB 15P terminal.
- The computer shown in the illustration is for example purposes only. Additional equipment and cables shown are not supplied with this set.
- The picture will become dark if an PC signal with a vertical scanning frequency of 62 Hz is input. To obtain the optimum picture quality with the Device Display, a vertical scanning frequency of 60 Hz is recommended.
- Do not set the horizontal and vertical scanning frequencies for PC signals which are above or below the specified frequency range.
- Select the desired RGB input position by pressing the TV/VIDEO button. (P. 37)
- Similar connections are available at the RGB IN 1, 2 Terminals.

RGB signals that can be input

The table below lists the different types of RGB signals that can be input.

If a signal which differs greatly from any of the types listed below is input, the picture image may not be displayed correctly, or a black background may be displayed. At this time, "signal" will flash in the on-screen display for about 5 seconds.

Mode type		Signal data			Information menu display
		No. of dots (H X V)	Horizontal frequency (kHz)	Vertical frequency (Hz)	
Personal Computer Signals	VGA400 (70 Hz)	640 X 400	31.47	70.08	VGA400 70Hz
	VGA480 (60 Hz)	640 X 480	31.47	59.94	VGA 60Hz
	Macintosh 13"	640 X 480	35.00	66.67	MAC 13
	VESA400 (85 Hz)	640 X 400	37.86	85.08	VESA 85Hz
	VESA480 (72 Hz)	640 X 480	37.86	72.81	VGA 72Hz
	VESA480 (75 Hz)	640 X 480	37.50	75.00	VGA 75Hz
	VESA480 (85 Hz)	640 X 480	43.27	85.01	VGA 85Hz
	SVGA (56 Hz)	800 X 600	35.16	56.25	SVGA 56Hz
	SVGA (60 Hz)	800 X 600	37.88	60.32	SVGA 60Hz
	SVGA (72 Hz)	800 X 600	48.08	72.19	SVGA 72Hz
	SVGA (75 Hz)	800 X 600	46.88	75.00	SVGA 75Hz
	SVGA (85 Hz)	800 X 600	53.67	85.06	SVGA 85Hz
	Macintosh 16"	832 X 624	49.73	74.55	MAC 16
	* XGA (60 Hz)	1 024 X 768	48.36	60.00	XGA 60Hz
	* XGA (70 Hz)	1 024 X 768	56.48	70.07	XGA 70Hz
	* XGA (75 Hz)	1 024 X 768	60.02	75.03	XGA 75Hz
* Macintosh 19"	1 024 X 768	60.24	74.93	MAC 19	
DTV Format Signals	480i	664 X 485	15.73	29.97	480 i
	480p	720 X 483	31.47	59.94	480 p
	720p	1 280 X 720	45.00	60.00	720 p
	*1080i	1 920 X 1 080	33.75	30.00	1080 i

Notes:

- Input signals, other than those listed with a * mark, will give you a beautiful, stable picture.
- The D-SUB15P connector can accept RGB (H-V sync separate) and RGB (sync on green). However, it is not guaranteed to display stable color when using RGB (sync on green).
- When used with an external video processor/scaler, it must have RGB (H-V sync separate) output.

Installation

How to connect the HDMI input terminal

About HDMI

HDMI is the first all digital consumer electronics A/V interface that supports several uncompressed standard, enhanced and high definition video format as well as all existing multi-channel audio formats. One jack supports both video and audio information. The HDMI/HDCP¹ input can be connected to an EIA/CEA 861/861B² compliant consumer electronic device, such as a set top box or DVD player equipped with a HDMI output connection. By inputting a High-bandwidth Digital Content Protection (HDCP) high definition picture source to the HDMI terminal of this unit, high definition pictures can be displayed on the screen in their digital form. The HDMI input terminal is not intended to be used with personal computers. This unit is compatible with 1080i, 720p and 480p formats. Select the output of the connected device to match that of the unit.

Connection diagram

Follow the diagram below to connect the unit to a set top box or a DVD player.

When audio signal input is digital.

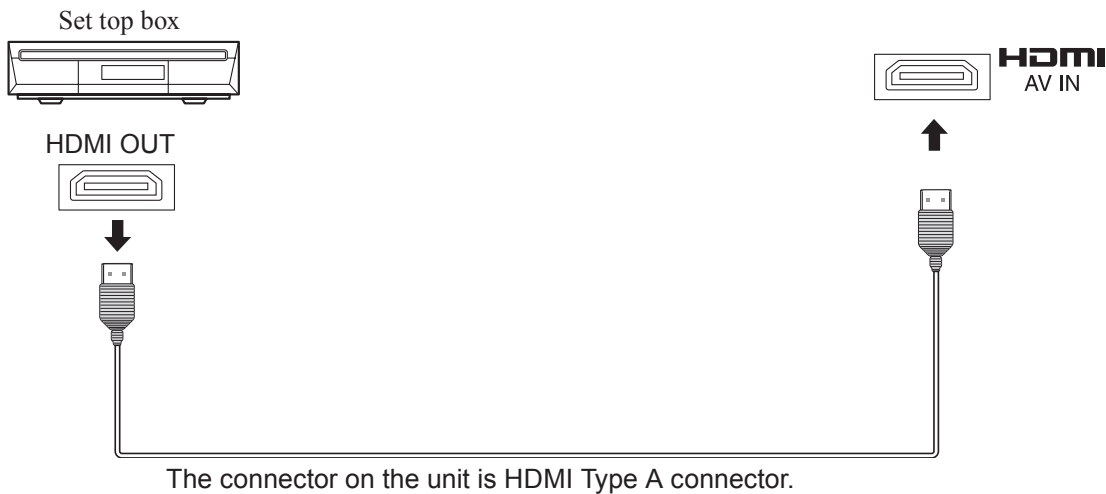

When audio signal input is analog.

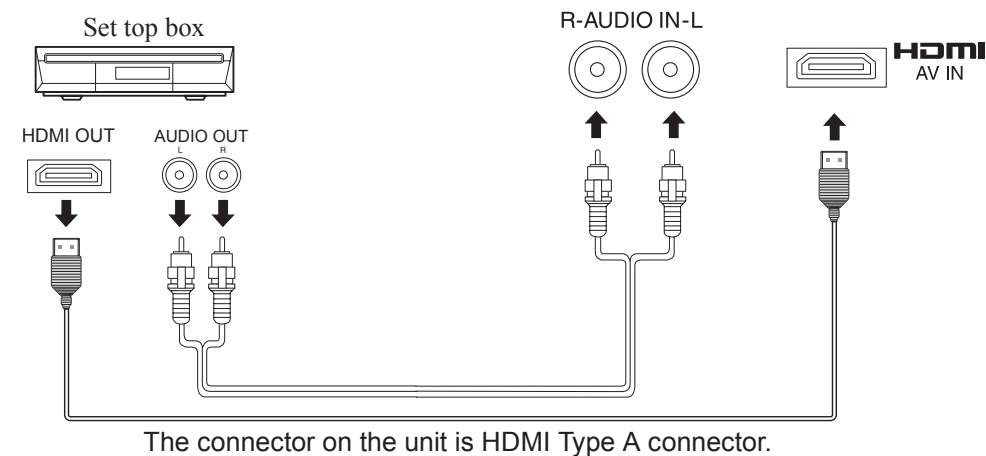

Notes:

¹ HDMI/HDCP = High Definition Multimedia Interface / High-Bandwidth Digital Copy Protection.

² EIA/CEA-861/861B Profiles compliance covers profiles for transmission of uncompressed digital video including high bandwidth digital content protection.

Procedure

- 1** Connect the HDMI output from the set top box or a DVD player to the HDMI input on the back of the unit.
 - If you cannot display the picture because your Digital Set Top Box does not have a Digital Out terminal setting, use the Component Video Input (or the S-Video Input or Video Input). In this case, the picture will be displayed as an analog signal.

- 2** Press TV/VIDEO on the Remote Control to select HDMI input.

By inputting a High-bandwidth Digital Content Protection high-definition picture source to the HDMI IN terminal of this Device Display, high-definition pictures can be displayed on the screen in their digital form. (This terminal is for use in the future when High-bandwidth Digital Content Protection DVD players and D-VHS are put on the market.)

Notes:

- Select the HDMI input position by pressing the TV/VIDEO button. (P. 37)
- The HDMI IN terminal can only be used with 1080i, 720p and 480p picture signals.
- If there is no audio, check if the source equipment has PCM output. If not, please use analog connections.
- Be sure HDMI is securely connected. If not, picture noise and/or incorrect picture display may result.
- With HDMI connection, depending on the signal, the picture may be displayed with unnatural colors (as if red and blue are reversed). See UV Timing of Page 53.

Compatible formats

Video Signal:

The Device display is compatible with following formats. Please set the connecting device to following format.

Display mode	No. of dots	Vertical scanning frequency (Hz)
1080i	1920 x 1080i	59.94 / 60
720p	1280 x 720p	59.94 / 60
480p	720 x 480p	59.94 / 60
	640 x 480p	59.94 / 60

Audio signal (PCM)

When digital audio is included in the HDMI connection, the compatible sampling frequencies are 48 kHz/44.1 kHz/32 kHz. (See page 55)

Power ON / OFF

Turning the Power ON and OFF

Always be sure to follow the procedure given below to turn the Device Display power ON and OFF.

- The lamp cooling fan will continue to operate for approximately 1 minute after the power is turned off. At the same time, the POWER indicator will blink Red.

Do not disconnect the power cord from the outlet and do not open the circuit breaker (unless necessary) while the cooling fan is still operating. Do not disconnect the power cord from the power outlet while the power indicator blinks Red.

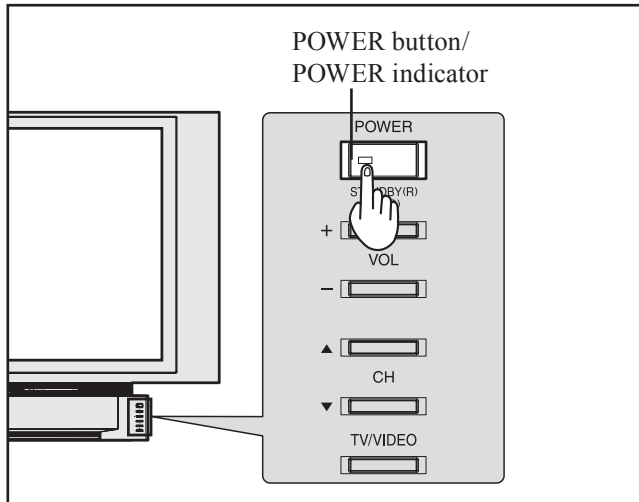

Power ON

Press POWER on Device Display or Remote Control to turn power on.

The Power Indicator blinks Green for about 10 seconds and then turns solid Green.

Power OFF

Press POWER on Device Display or Remote Control to turn power off.

Power shuts off after a Black Screen is displayed for a few seconds.

Note:

If the POWER button is pressed during the Black Screen display, Power is turned back on.

The Power Indicator blinks Red for about 1 minute and then turns solid Red.

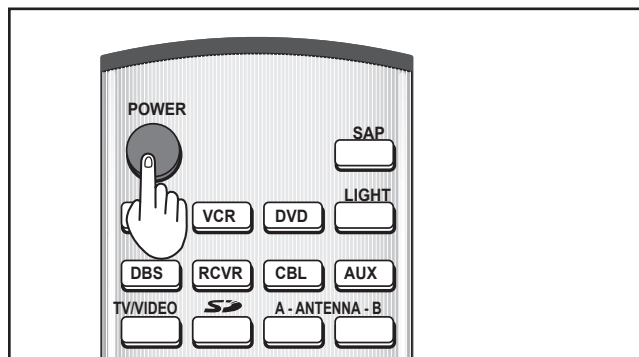

Note:

When the AC Cord is unplugged, the internal cooling fan stops operating. In this case, the lamp will be insufficiently cooled and will take a while to turn ON again.

The Power Indicator

LED	ACTION
Red	Power – OFF (Standby mode)
Red blink	Power – OFF (Now cooling)
Green	Power – ON
Green blink	Power – ON (Preparing to light lamp)

Notes:

- If the POWER button is accidentally turned off during use, after power is turned back on, it may take a short period before the lamp automatically comes on.
- After the unit is turned on, maximum picture brightness will be achieved in 5-10 minutes. This is normal.
- This unit consumes approx. 20 W in OFF condition when plugged into an AC outlet.

First Time Setup

For your convenience, First Time Set up menu will be displayed on screen when the set is turned on for the first time. If needed, follow the menus and procedures displayed on-screen for setting up the features.



Input Setup

To select the configuration of RF input depending on the signal source.

Note:

No video will be displayed in this setup mode.

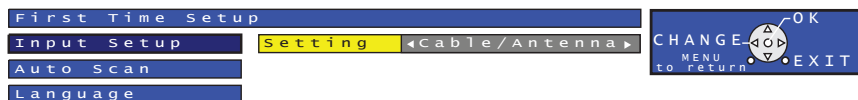

Procedure

Press VOL ► to select Cable only, Cable/Antenna, or Antenna only.
Press OK to underline your selection.

When the next screen is displayed, press OK to start the Auto Scan. All available channels with a signal will be programmed into memory.

Auto Scan

This feature allows you to selectively auto scan channels. You can Scan All, Analog only channels, or Analog & Digital channels.

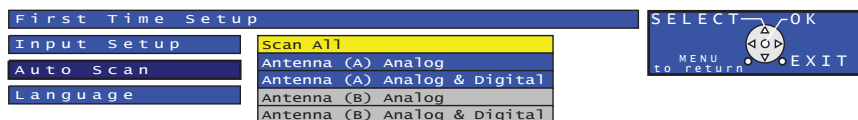

Procedure

Press OK to start Auto Scan.

After Auto Scan is completed the unit tunes to the first channel found during auto scan.

Notes:

- If DCM (Digital Cable Module) is present during the First Time Setup and Antenna (A) is set to cable, Antenna (A) will not be scanned due to the DCM providing the channel map.
- If setup is incomplete, check connection of Antenna/Cable to the RF IN Terminal, then try Auto Scan again. (PP. 30-31)

Language

The language of the on-screen display is set to English as the factory setting. You can select English, Spanish or French as the on-screen displays language.



Procedure

Press ◀ VOL or VOL ► to select desired language, then press OK to set.

Notes:

- Auto scan must be done when you select the input signal for the first time or whenever you change the antenna configuration.
- Depending on conditions, Auto scan may take a while.

Basic Menu Navigation



1 Pressing MENU displays the Main Menu screen.

MENU Pressing MENU again displays previous level menu.

Note: Depending on the signal being input, some items may or may not be adjustable and some functions may or may not be available.

2

Press

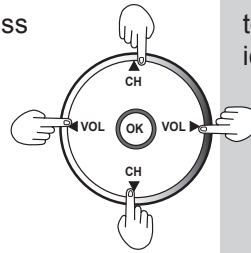

to select the desired icon.

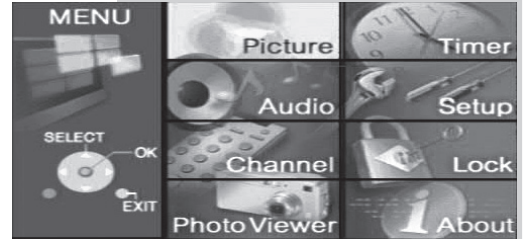

Press



to enter the menu.

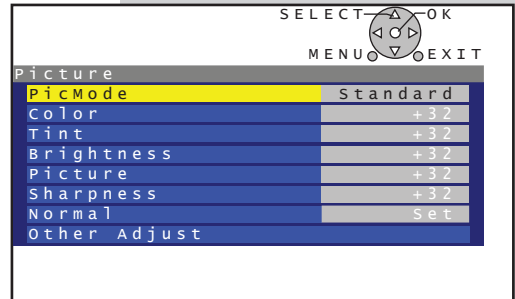

Press

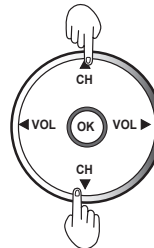

to select desired menu item.

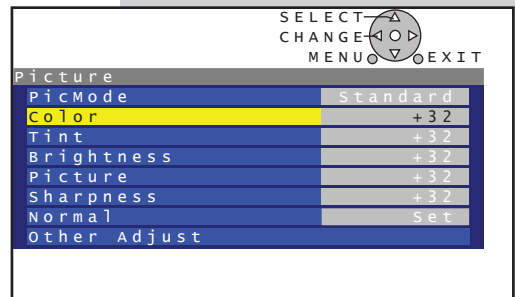

Continued in left column of next page.

Basic Menu Navigation

Continued from page 28.

Press  to adjust or set desired menu item.

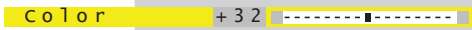

Note: For Other Adjust sub-menu.

Press  to select Other Adjust.

Picture	
PicMode	Standard
Color	+32
Tint	+32
Brightness	+32
Picture	+32
Sharpness	+32
Normal	Set
Other Adjust	

Press  to access Other Adjust sub-menu.

Other Adjust	
Color Temp	Normal
Video NR	off
3D Y/C	on
Color Matrix	SD
3D I/P	off
ID1	on

Continued in right column.

Continued from left column.

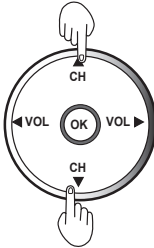
Press  to select desired sub-menu items.

Other Adjust	
Color Temp	Normal
Video NR	off
3D Y/C	on
Color Matrix	SD
3D I/P	off
ID1	on

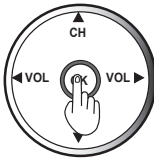
Press  to select desired sub-menu items.

Other Adjust	
Color Temp	Normal
Video NR	on
3D Y/C	on
Color Matrix	SD
3D I/P	off
ID1	on

Note: To EXIT menus.

Press  repeatedly until normal picture is displayed.



Press  to return to normal picture.



Tuning channels

Automatic channel setting

Automatically searches and adds receivable channels to memory.



Press MENU to display the Main Menu screen.

1

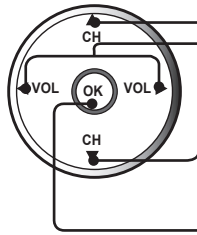

Press to select Setup icon.

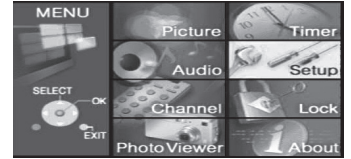

Press to display the options in the Setup menu.

2

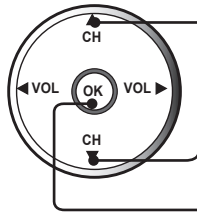

Press to select Program CH icon.

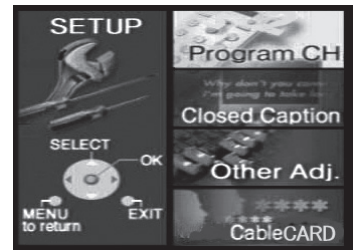

Press to display the Program Channel menu.

3

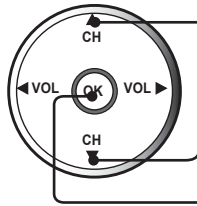

Press to select Input Setup.

Press to enter the sub-menu.

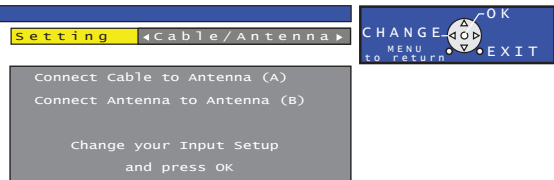
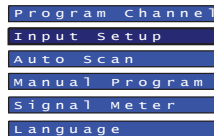

4

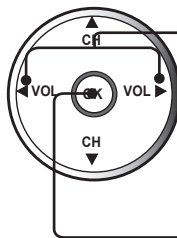

Press to select Cable Only, Cable/Antenna or Antenna Only.

Note:

TV or Cable Tuning mode must be set according to your connections.

Press to set.

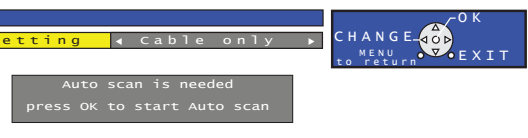
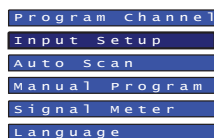

Continued on the next page.

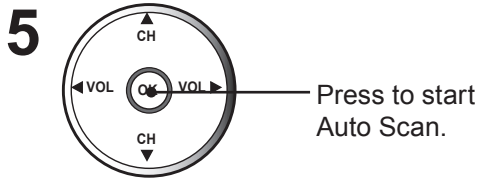

Notes:

- If Cable Only, Antenna Only or Antenna/Cable is selected and DCM (Digital Cable Module) is not in, the Auto Scan will perform Scan All.
- If Cable Only is selected and DCM is in, Auto scan will be skipped.
- If Cable/Antenna is selected and DCM is in, Antenna (B) Analog & Digital Auto scan will be performed.

Auto Scan - To automatically Scan All available channels, Antenna (A) Analog, Antenna (A) Analog & Digital, Antenna (B) Analog and Antenna (B) Analog & Digital.

1 Select Auto Scan and press OK to enter the sub menu.

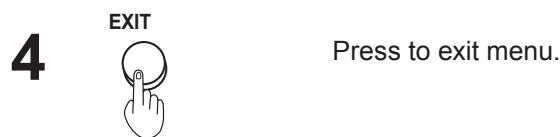
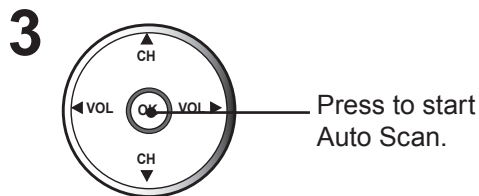
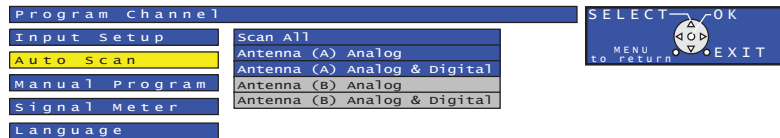
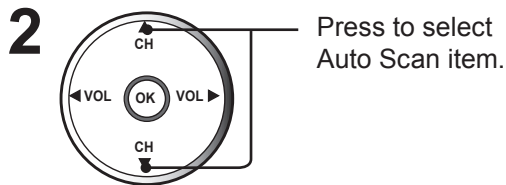

Notes:

- Some channels with very weak signals may be locked into memory. If desired, these channels can be deleted manually using the Manual Program feature.
- Auto scan must be done when you select the input signal for the first time or whenever you change the antenna configuration.

Tuning channels

Manual channel setting

Use this procedure when changing setting of receiving channels or changing the channel display.
To add or delete channels from either channel list (A/B) manually.



Press MENU to display the Main Menu screen.

1

Press to select Setup icon.

Press to display the options in the Setup menu.

2

Press to select Program CH icon.

Press to display the Program Channel menu.

3

Press to select Manual Program.

Press to enter sub-menu.

Program Channel		SELECT	OK
Input Setup	RF Input	Antenna (A)	MENU to return
Auto Scan	Channel Add	A: 2	
Manual Program	Channel Del	A: 66	
Signal Meter			
Language			

4

Press to select RF Input.

RF Input can only be selected when both Antenna (A) and Antenna (B) are connected.

Press to select Antenna (A) or Antenna (B).

Program Channel		SELECT	OK
Input Setup	RF Input	Antenna (A)	CHANGE MENU to return
Auto Scan	Channel Add	A: 2	
Manual Program	Channel Del	A: 66	
Signal Meter			
Language			

5

Press to set.

Continued on the next page.

6 To add channel

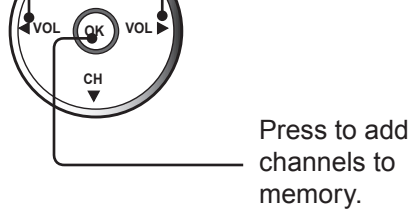
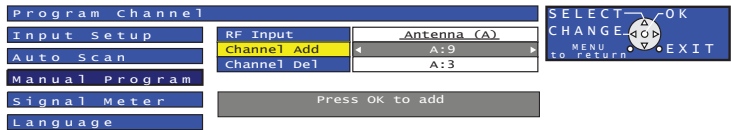
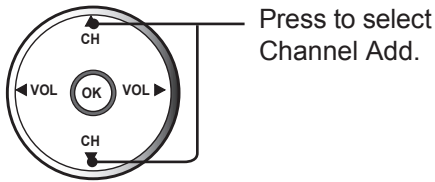

To delete channel

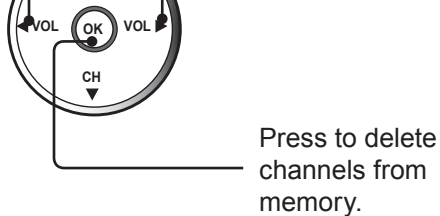
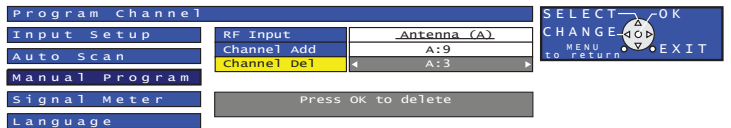
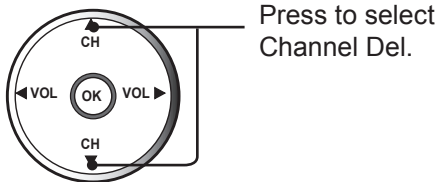

7 Repeat steps 6 to continue adding or deleting channels.

8  Press to exit menu.

Note:

Some channels with very weak signals may be locked into memory. If desired, these channels can be deleted manually using the Manual Program feature.

Device display operation

Operation can be done from the Device Display.

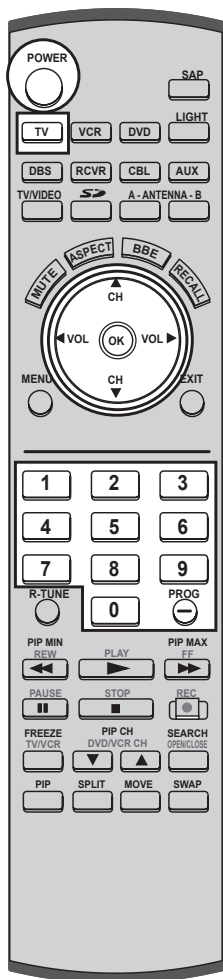
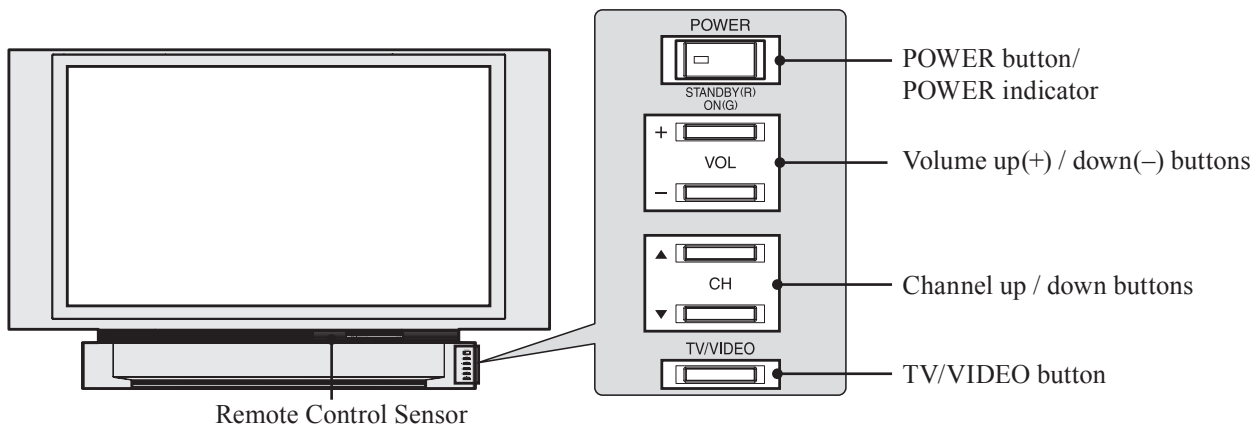

- 1**

Press to operate the Device Display with the Remote Control.
- 2**

Press to turn the Device Display on.
- 3**

Press to select the desired channel.

Note:
Refer to "Channel Up/Down Tuning". (See page 36.)

Or

Use number keys

Note:
Refer to "Direct Tuning Method". (See next page.)
- 4**

Press to select the desired volume level.

Notes:

- The channel number and volume level are stored even after the Device Display is turned off.
- Power consumption can be reduced if the volume level is lowered.

Channel and Program Tuning

Channel and Program tuning in digital television differs from conventional television. With DTV, many programs can exist within a single 6 MHz channel. These channels behave as sub-channels within a single channel. When tuning to a digital channel, the Device Display will also tune to a program and will indicate the channel and program in the on-screen Channel Banner display.

In order to select channels properly, Auto Scan must be performed (refer to pages 30-31).

Direct Tuning Method

Follow the procedure below to directly enter the channel number using the Remote Control number keys.

Select analog channel

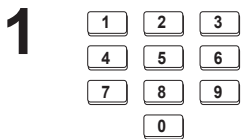

Press the number keys on the Remote Control to enter the Channel number. Press OK.
The following is an example of tuning to channel 15.

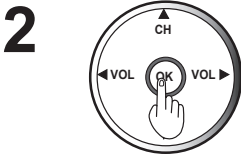

Direct Tuning Example

Step	Action	Channel Banner Display
1	Press 1	1
2	Press 5	15
3	Press OK	15

Select digital channel



If tuning a digital channel and your channel contains more than one program, press PROG and enter the program (1, 2, 3 etc.) using the number keys. Press OK.
The following is an example of tuning to channel 15-1.

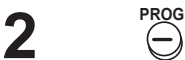

Direct Tuning Example

Step	Action	Channel Banner Display
1	Press 1	1
2	Press 5	15
3	Press -	15-
4	Press 1	15-1
5	Press OK	15-1

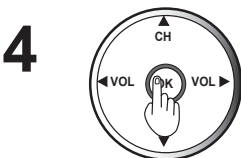

Device display operation



Rapid Tuning

Switches between the current and last channel or program.

R-TUNE



Press to switch to previously viewed channel, Photo Viewer or input modes.

Antenna Input (A/B) Tuning

A - ANTENNA - B



A/B button switches between the two RF antenna inputs, if connected. The last tuned channel in memory of the respective RF input is displayed.

Changing the input signal

The input source for picture signals can be changed by pressing TV/VIDEO, SD on the Remote Control or TV/VIDEO on the unit.

Remote Control



The input mode changes each time this button is pressed.

*1 If SKIP is set as the Input Label setting of Channel Caption, the mode will not be changed. (See page 71.)



Card input mode (Photo Viewer) is selected.

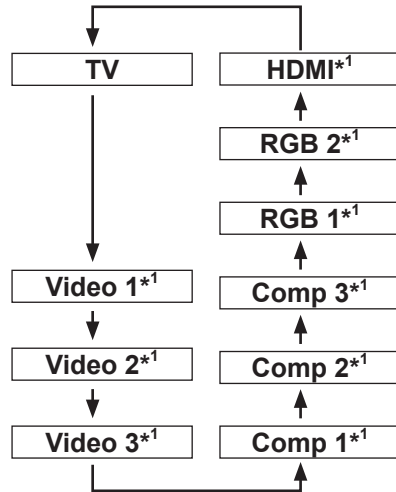

Or

Device display Unit

TV/VIDEO

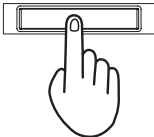

*1 Changing input is only possible if Cable/Antenna is set as the Input Set setting.

*2 If SKIP is set as the Input Label setting of Channel Caption, the mode will not be changed. (See page 71.)

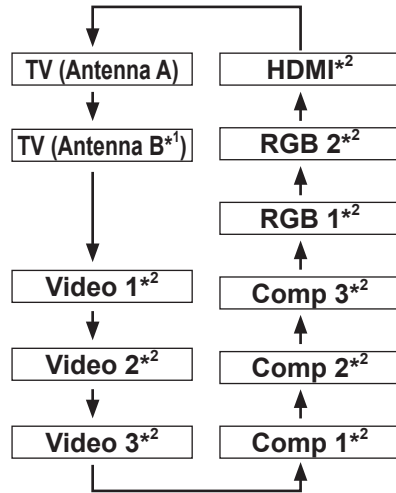

Video 1	Signal of source connected to INPUT 1 is displayed.
Video 2	Signal of source connected to INPUT 2 is displayed.
Video 3	Signal of source connected to INPUT 3 is displayed.
Comp 1	Signal of source connected to COMPONENT VIDEO INPUT 1 is displayed.
Comp 2	Signal of source connected to COMPONENT VIDEO INPUT 2 is displayed.
Comp 3	Signal of source connected to COMPONENT VIDEO INPUT 3 is displayed.
RGB 1	Signal of source connected to RGB IN 1 is displayed.
RGB 2	Signal of source connected to RGB IN 2 is displayed.
HDMI	Signal of source connected to HDMI IN is displayed.
Photo (Photo Viewer)	Signal of source connected to CARD SLOT is displayed.

Device display operation



Unit Status display



Press the RECALL, Channel UP/DOWN or TV/VIDEO button, except when the MENU screen is displayed, to display current unit status information.

Or

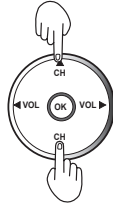

Or

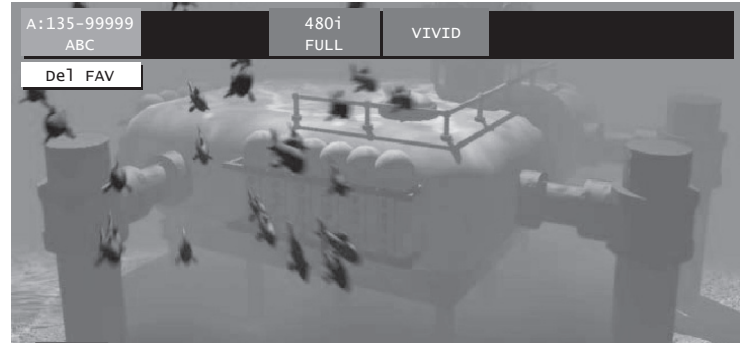

Channel Banner: Minimized

Press Channel UP/DOWN or TV/VIDEO to minimize the channel banner display. It will display the antenna input, channel number, and the station identification (if available).

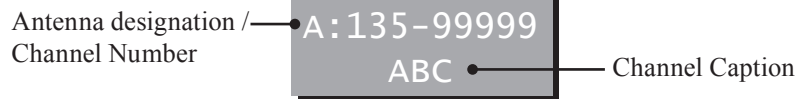

Channel Banner: Maximized

Press RECALL to maximize the channel banner display. While it is displayed, you can add a channel to or delete a channel from the Favorite channel list.

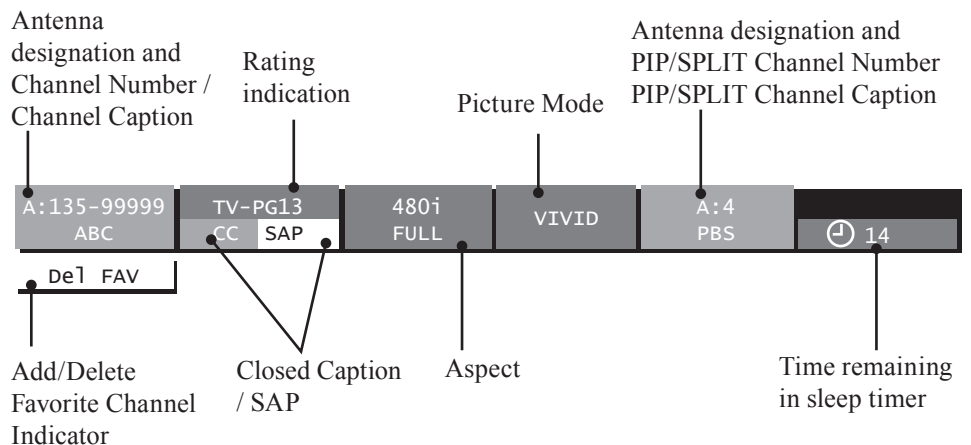

Continued on the next page.

Add FAV / Del FAV feature

This feature lets you add channels to or delete channels from the Favorite channel list.

1 Tune to the desired channel to be added or deleted.

2 To add a favorite channel

Press RECALL while viewing an unregistered channel to display Add FAV in the CH Banner.

Press OK to add the channel.

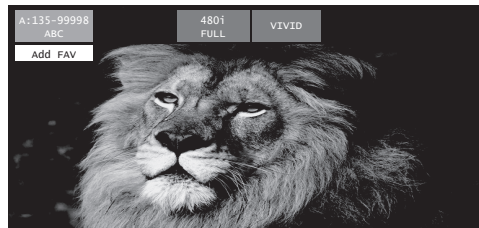

To delete a favorite channel

Press RECALL while viewing a registered channel to display Del FAV in the CH Banner.

Press OK to delete the channel.



Note:

Please refer to page 49 for more about the Favorite Channel feature.

Auto shut off

To extend lamp life, if there is no signal to the set's tuner for 5 minutes, the lamp will shut off automatically.

Invalid operation notification

If an invalid operation is attempted, the mark shown right is displayed.



Example: Invalid operation was tried during FREEZE mode.

ASPECT Controls

The color monitor will allow you to enjoy viewing the picture at its maximum size, including wide screen cinema format picture.



The aspect mode changes each time ASPECT is pressed.

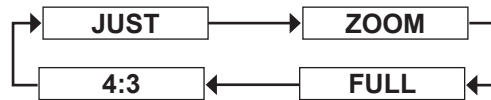

- When a 480p signal is being received, the mode switches between 4:3, ZOOM, and FULL only.



- During PC input, the mode switches between 4:3, FULL and TRUE only.



- When XGA and Mac 19 signal is input, the aspect will be 4:3 and FULL only.

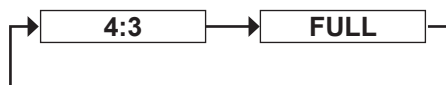

Notes:

- When a 1080i or 720p signal is being received, the mode is set to FULL, and aspect switching is not possible.
- When input mode is CARD, the mode is set to 4:3, and aspect switching is not possible.

Notes:

- However, if the mode selected does not match the aspect ratio of the input signal, the original picture quality may be affected.
- If using this Device Display in places, such as cafes or hotels, with the aim of displaying programs for a commercial purpose or for public presentation, please note that by using the aspect ratio (16:9) selection function to change the aspect ratio, you may be infringing on the rights of the original copyright owner of that program under copyright protection laws.
- If a 4:3 picture is projected in wide screen, distortion may occur around the edges so that part of the picture may no longer be visible. We recommend viewing in 4:3 mode so you can enjoy the picture as it was intended to be seen.

ASPECT Controls

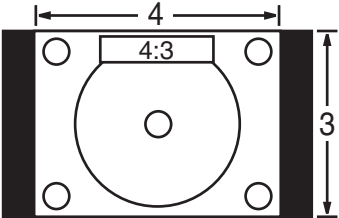
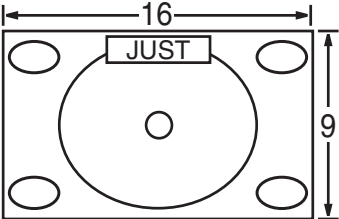
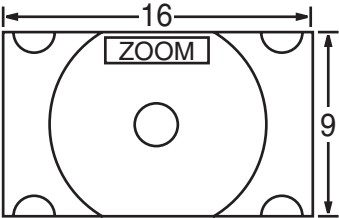
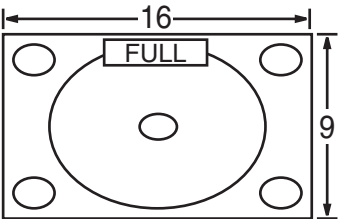
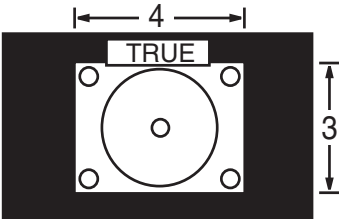
Mode	Picture	Explanation
4:3		<p>4:3 will display a 4:3 picture at its standard 4:3 size.</p>
JUST		<p>JUST mode will display a 4:3 picture at maximum size but with aspect correction applied to the center of the screen so that elongation is only apparent at the left and right edges of the screen. The size of the picture will depend on the original signal.</p>
ZOOM		<p>ZOOM mode magnifies the central section of the picture.</p>
FULL		<p>FULL will display the picture at its maximum size but with slight elongation.</p>
TRUE		<p>You can reduce the image and adjust it to the original image quality. (Except XGA)</p>

Notes:

- The screen size changes if ID1 is detected. (P. 77)
- When ASPECT is in ZOOM mode, PIP feature cannot be used. (PP. 44-45)

Mute / Freeze / SAP



Sound mute



Useful when answering the phone or receiving unexpected visitors

Press this button to mute the sound. Press again to reactivate sound. Sound is also reactivated when power is turned off or volume level is changed.

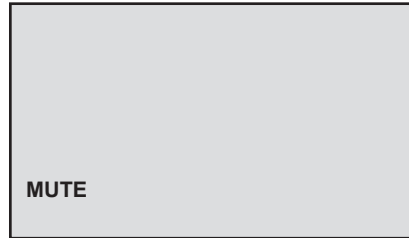

Note:

The audio output from AV OUT is not muted.

Freezing pictures



Projection can be switched between a frozen (still) picture and a moving picture each time FREEZE on the Remote Control unit is pressed. Press FREEZE again to resume motion.



Note:

The video output from AV OUT is not frozen.

Select Audio Mode for TV Viewing

In digital mode,



Press SAP to select the next audio track (if available) when receiving a digital channel.

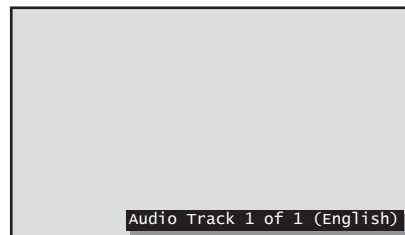

Continued on the next page.

In analog mode,



Press SAP button to select the desired audio mode as described below.
 (Arrow shows selection.)

- Each press of SAP button will change the audio mode as shown below.
- “SAP” is selected with first press of SAP button.

Example:

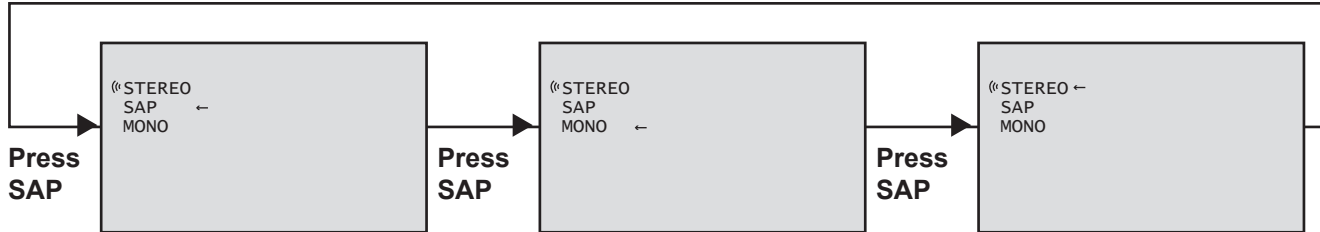

Receivable Broadcast Types

The following are possible broadcast types with their accompanying on-screen displays. The signal being received is indicated with a “«” mark while the selected audio mode is indicated with an arrow.

MTS Stereo and SAP broadcast

Multi-channel Television Sound Stereo (main language) and Secondary Audio Program (sub language) broadcasts are both being received simultaneously. Select the STEREO or SAP audio mode.

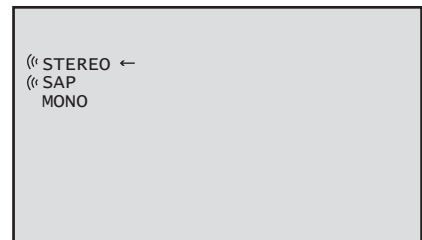

MTS Stereo broadcast

Multi-channel Television Sound Stereo broadcast. Select STEREO audio mode.

- If stereo broadcast is weak and the display flickers, select MONO audio mode for possibly better results.

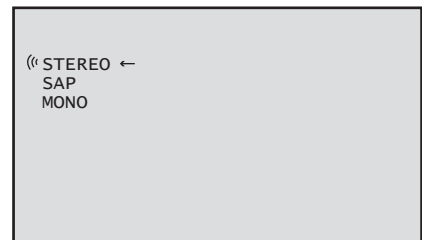

SAP broadcast

Secondary Audio Program (sub language.)
 Select SAP audio mode for the sub language.

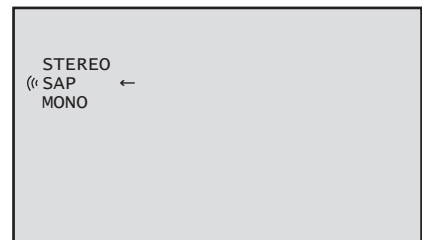

MONO broadcast

Normal monaural sound broadcast.

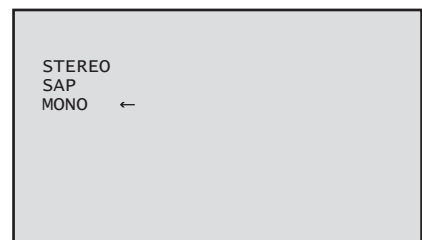

Picture in Picture (PIP) Screen

This unit includes a two-tuner Picture In Picture (PIP) feature. This allows you to watch two (2) live broadcasts at the same time with or without an external video source, such as a VCR, cable box, etc.



Display PIP screen



Press to split.
(The previously selected screen appears on the Main.)



Main screen
(Main picture)

PIP screen
(Sub picture)

Returning to one screen



Press to return.

Select desired input mode of the PIP screen



Press to select the desired input mode.

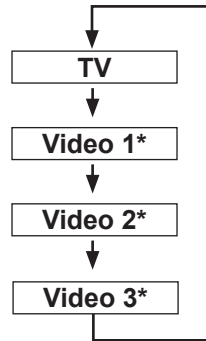

*If SKIP is set as the Input Label setting of Channel Caption, the mode will not be changed. (See page 71.)

Notes:

- Sound from the Main screen is output from the speakers on the Device Display set.
- In PIP mode, the Main screen signal is output from the rear monitor output terminal.
- Because Main and PIP screens are processed by individual circuits, image quality may vary slightly.
- PIP mode returns to single screen when the Device Display is turned off.
- Essentially, the Main and PIP screens cannot display the same picture at the same time.
- Only the Analog programming from Antenna (A) and video inputs signal can be viewed in the PIP screen function.
- A component signal cannot be displayed on a PIP screen. Thus, when a component signal is displayed on the Main screen, the SWAP button becomes invalid.
- When ASPECT is in ZOOM mode, PIP feature cannot be used. (PP. 40-41)
- When the RGB, HDMI or Card (Photo Viewer) input mode is selected, PIP feature cannot be used. (P. 37)
- The signal input from Antenna (B) can be displayed on the Main screen only. (It cannot be displayed as a PIP screen.)

Picture in Picture (PIP) Screen

Changing the channel of the PIP screen

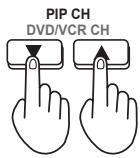

Press to select the desired channel.

Example:
During Main screen NORMAL

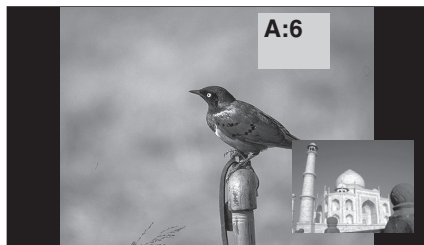
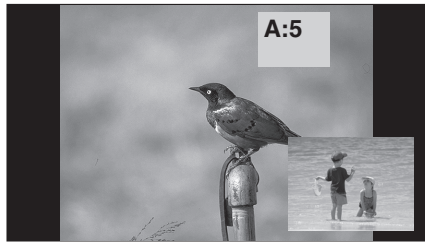

Swapping Main and PIP screens



Press to swap.

Example:
During Main screen NORMAL

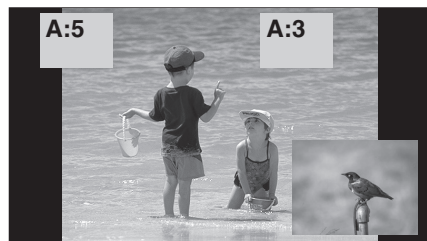
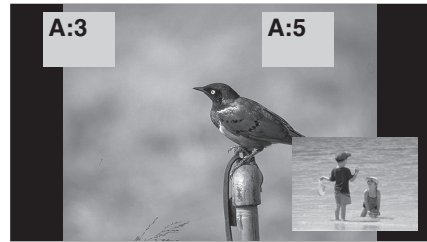

Selecting the screen size for PIP screen

You can choose PIP screen size of 3 magnifications.



Press to large PIP screen size. → ①



Press to small PIP screen size. → ②

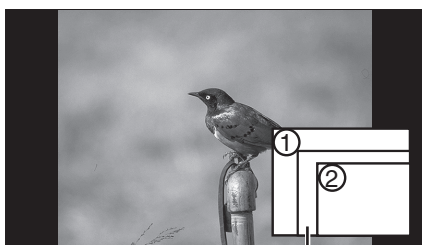

Initial size

Note:

The last size chosen is saved and will not be erased even if the power is turned off.

Move PIP screen

You can move the PIP screen to four positions.



Press repeatedly to select PIP position.

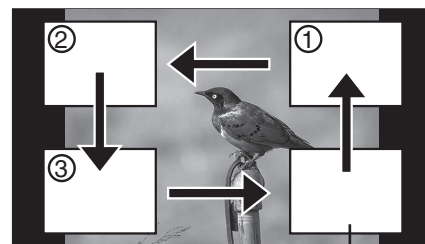
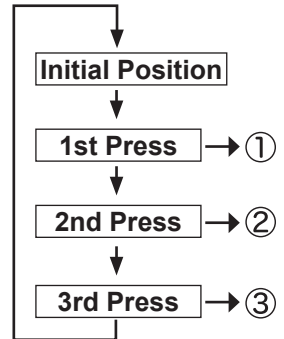

Initial position

Note:

The last position chosen is saved and will not be erased even if the power is turned off.

Split screen



Splitting the screen



Press to split.
(The previously selected screen appears on the left.)

Left screen
(Main picture)

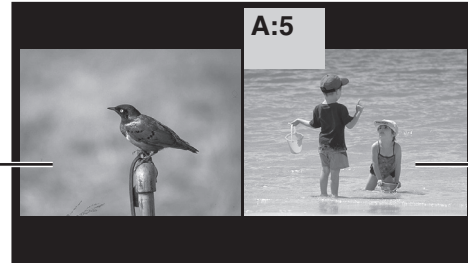

Right screen
(Sub picture)

Returning to one screen



Press to return.

Selecting the screen aspect for split screen.



Press to select modes.

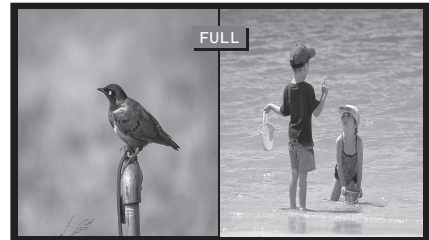

SPLIT SCREEN FULL

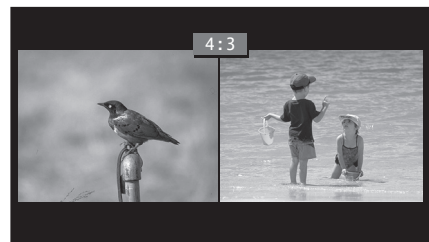

SPLIT SCREEN 4:3

(According to the signal, the display may not have an aspect ratio of 4:3.)



SPLIT SCREEN 4:3

(Example: RGB input)

Notes:

- Sound from the Left screen is output from the speakers on the Device Display set.
- When the screen is split, signals of the Left screen are output from the rear monitor output terminal.
- The left and right screens are processed by individual circuits and, therefore, may vary in image quality.
- Split screen returns to single screen when the Device Display is turned off.
- The right and left screens essentially cannot display the same picture at the same time.
- A split screen which includes an RGB IN signal is fixed as SPLIT SCREEN 4:3. (Example: RGB input is shown right.)
- CARD and HDMI input screen cannot be displayed using the Split Screen function.
- The signal input from Antenna (B) is displayed on the Left screen only. (It cannot be displayed on the Right screen.)

Changing the channel of the right screen

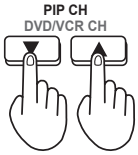

Press to select the desired channel.

Example:
During SPLIT SCREEN NORMAL

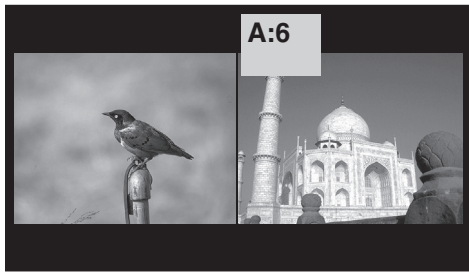
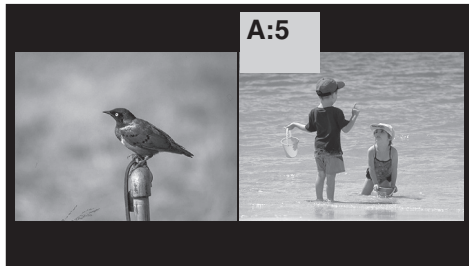

Swapping left and right screens



Press to swap.

Example:
During SPLIT SCREEN NORMAL

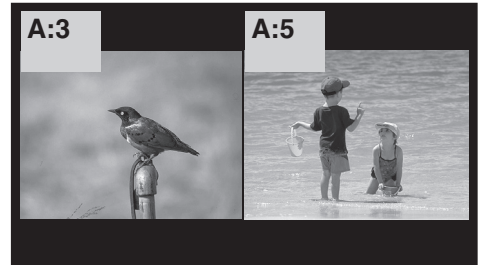

Select desired input mode of the Right screen



Press to select the desired input mode.

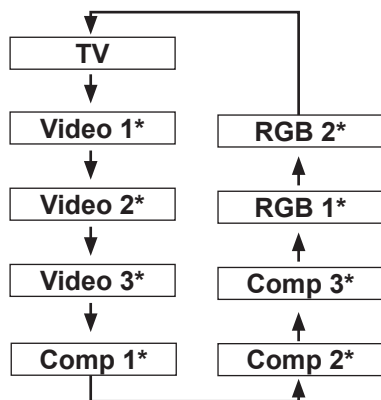

*If SKIP is set as the Input Label setting of Channel Caption, the mode will not be changed. (See page 71.)

Example:
During SPLIT SCREEN NORMAL
(RGB input)

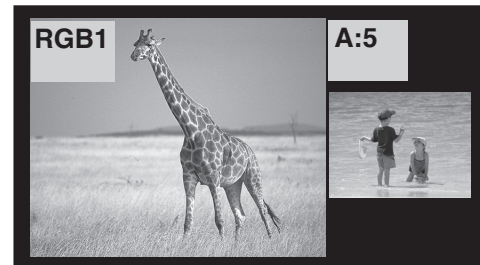

Note:

Picture quality may change according to the combination of signals input to the left and right screens.

Searching for the desired channel (Channel search)

Channel search displays each channel, in order, as a paused image. Channels are displayed from the left top to the right bottom in order. When it reaches the right bottom, the next channel is displayed at the left top, overwriting the previously displayed channel.

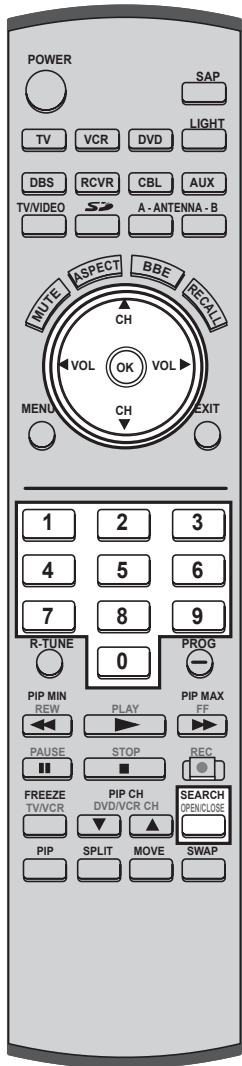

Notes:

- To end channel search, press SEARCH/OPEN/CLOSE.
- While using the PIP feature, Channel search is not available.
- Channel search feature works with analog channels only. ATSC channel search is not possible.
- When CARD and HDMI input screen is displayed, no search is possible.
- Channel search feature works only if signal is from Antenna (A).

SEARCH
OPEN/CLOSE



When SEARCH/OPEN/CLOSE is pressed during single screen.



Example 1

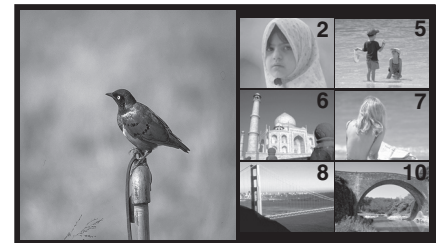

Example 2 (RGB input)

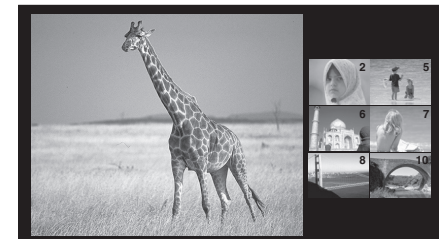

When a channel button is pressed during channel search.

Number keys:

Example: When 6 is pressed, channel 6 is displayed in single screen.

Channel up and down buttons:

When ▲ or ▼ is pressed, the next channel up or down is displayed in single screen.

Example: Select channel 6

Sound from the left screen is output from the speakers on the Device Display set.

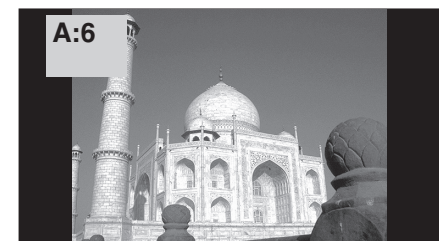

Favorite Channel Feature

Allows you to create a Favorite channel list from Antenna (A) or Antenna (B).



Press MENU to display the Main Menu screen.

1 Press to select Channel icon.

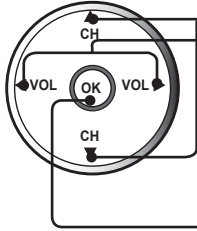

Press to display the options in the Channel menu.

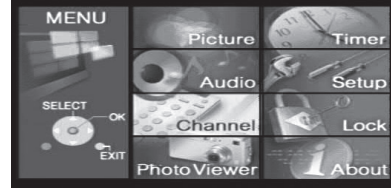

2 Press to select Favorite icon.

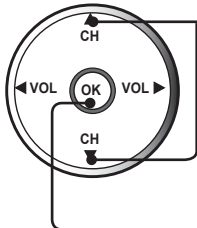

Press to display the Favorite menu.

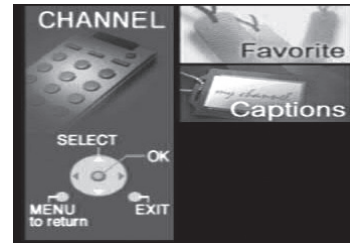

3 Press to select each item.

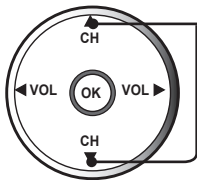

■ **Surf Mode:**

Select Favorite or All Channels with Remote Control ◀ VOL or VOL ▶, then press OK.

■ **RF Input:**

Select Antenna (A) or Antenna (B) with Remote Control ◀ VOL or VOL ▶, then press OK.

■ **Channel:**

Use the Remote Control ◀ VOL or VOL ▶ to select desired channels, then press OK to add. To delete channel, press OK again while channel number is displayed.

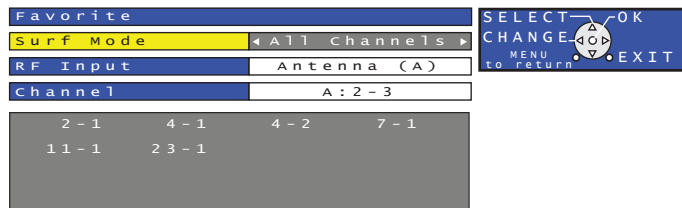

4 Press to exit menu.



Picture Adjustments



Press MENU to display the Main Menu screen.

1

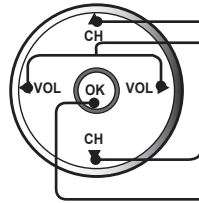

Press to select Picture icon.

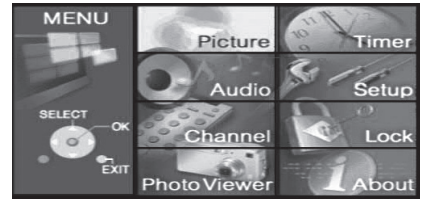

Press to display the Picture screen.

2

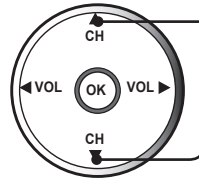

Press to select each item.

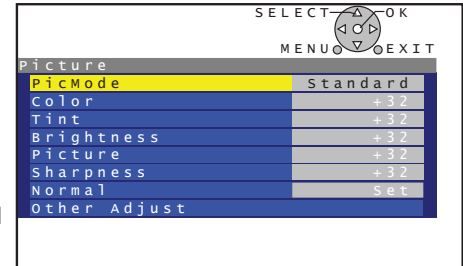

Note:
Normal is displayed at default.

RGB IN input

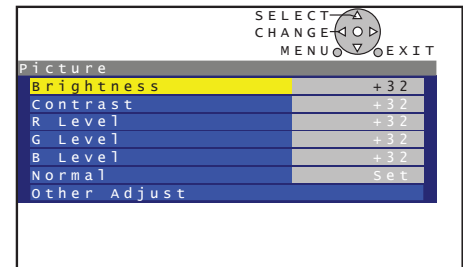

3

■ PicMode:

Lets you choose one of three pre-set Picture Modes that best suits the program you are viewing. Selecting this feature will also affect Color Temperature setting.

- VIVID - This is the default mode, It provides enhanced picture contrast and sharpness for viewing in a well-lit room.
- Cinema - Select this mode for watching movies in a darkened room. It provides a soft, film-like picture.
- Standard - Recommended for normal viewing conditions with subdued room lighting.

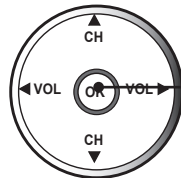

Press repeatedly to select PicMode.

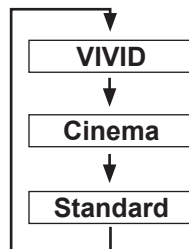

Note:

There is little change when PICTURE is increased with a bright picture or reduced with a dark picture.

Continued on the next page.

Picture Adjustments

- Color:
- Tint:
- Brightness:
- Picture:
- Sharpness:
- Contrast:
- R Level:
- G Level:
- B Level:

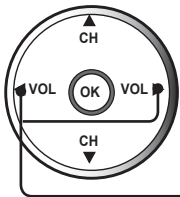

Adjust to desired level while viewing picture through the menu overlay. Press MENU or wait a few seconds to return to the previous menu screen.

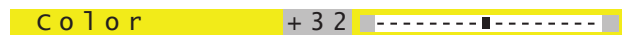

4



Press to exit menu.

Adjustment item	Button	Adjustment Details	Remarks
Color	Press ► button.	The color becomes deeper.	Except RGB IN
	Press ◀ button.	The color becomes paler.	
Tint	Press ► button.	Flesh tones become greenish.	Except RGB IN
	Press ◀ button.	Flesh tones become reddish.	
Brightness	Press ► button.	The screen becomes brighter.	
	Press ◀ button.	The screen becomes darker.	
Picture	Press ► button.	Picture intensity becomes stronger as both contrast and color levels are adjusted.	Except RGB IN
	Press ◀ button.	Picture intensity becomes weaker as both contrast and color levels are adjusted.	
Sharpness	Press ► button.	The picture quality becomes sharper.	Except RGB IN
	Press ◀ button.	The picture quality becomes softer.	
Contrast	Press ► button.	Only the Highlights of the image become brighter, adding Contrast.	RGB IN only
	Press ◀ button.	The Highlights become less bright, diminishing Contrast.	
R Level	Press ► button.	The red component becomes stronger.	RGB IN only
	Press ◀ button.	The red component becomes weaker.	
G Level	Press ► button.	The green component becomes stronger.	
	Press ◀ button.	The green component becomes weaker.	
B Level	Press ► button.	The blue component becomes stronger.	
	Press ◀ button.	The blue component becomes weaker.	

Adjusting screen position and size



Notes:

- This Device Display is equipped with various screen modes. If a screen mode with a different aspect from the broadcast program is selected, image will appear differently. Select the proper screen mode with this in mind. Be careful when using this Device Display for commercial purposes or for public use, such as in cafes and hotels. Shrinking and enlarging images by using screen mode switching function (zoom, etc.) may violate copyright laws. Images displayed on a wide screen TV will be cut off or distorted at the edges, when viewing normal aspect images of 4:3 in ZOOM, JUST or FULL mode. Display in 4:3 mode to view the original image intended by the producer.
- For 1080i and 720p input images, screen size cannot be adjusted.
- The adjusted setting will be kept even when the Device Display is turned off.
- The signals output from the VIDEO OUT terminal on the back of the Device Display is not affected when the screen size and position is adjusted.

1  Press to select the screen mode.

2  Press MENU to display the Main Menu screen.

 Press to select Setup icon.

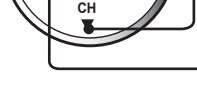
 Press to display the options in the Setup menu.

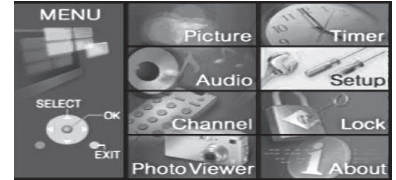

3  Press to select the Other Adj. icon.

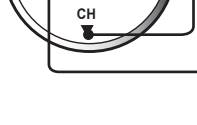
 Press to display the Other Adjustment menu.

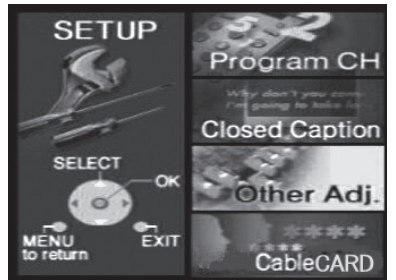

4  Press to select the Position/Size.

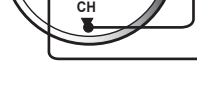
 Press to display Position/Size sub-menu.

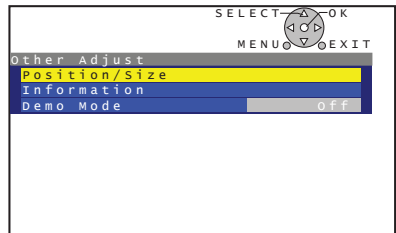

5  Press to select each item.

Note: Normal is displayed at default. Press to set or adjust to desired level. (See next page.)

JUST mode

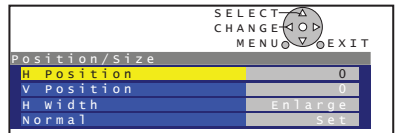

ZOOM mode

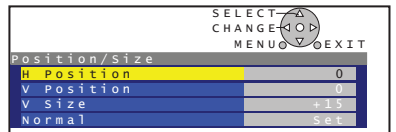

RGB input

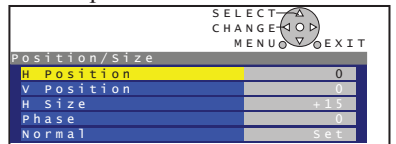

4:3 mode

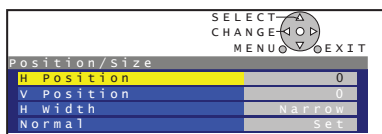

FULL mode

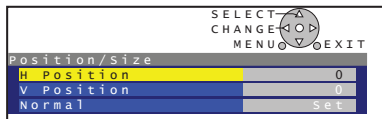



6  Press to exit menu.

Adjusting screen position and size

Adjustment item	Button	Adjustment Details	Note
H Position	Press ► button.	The image moves to the right.	
	Press ◀ button.	The image moves to the left.	
V Position	Press ► button.	The image moves up.	
	Press ◀ button.	The image moves down.	
H Width	Press OK button.	If noise appears on the ends of the image in Shrink, switch to Enlarge.	Only JUST mode
		If noise appears on the ends of the image in Widen, switch to Narrow.	Only 4:3 mode (Except PC input)
V Size	Press ► button.	Press to enlarge image vertically	Only ZOOM mode
	Press ◀ button.	Press to shrink image vertically	
H Size	Press ► button.	Press to enlarge image horizontally	RGB input
	Press ◀ button.	Press to shrink image horizontally	
Phase	Press ► button. Press ◀ button.	Adjust in order to remove any picture interference or contour blurring which may occur in computer images.	RGB input
Color Corr.	Press OK button.	With HDMI connection, depending on the signal, the picture may be displayed with unnatural colors (as if red and blue are reversed). Correct by setting the Color Corr. to Off. (Default is On.)	HDMI input

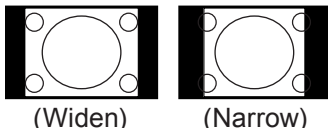
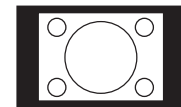
The OVER SCAN menu is added only when a 640 X 480 signal is input from the HDMI Input.

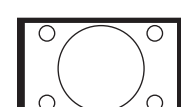
Adjustment item	Button	ASPECT	Overscan: ON (Normal display.)	Overscan: OFF (Picture is displayed smaller so it will fit on the screen.)
Overscan	Press OK button.	4:3 mode	 (Widen) (Narrow)	
		FULL mode		

Audio Adjustments

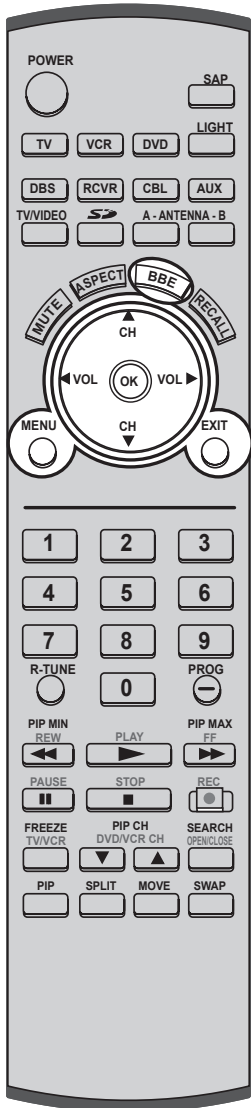

Press MENU to display the Main Menu screen.

1

Press to select Audio icon.

Press to display Audio menu.

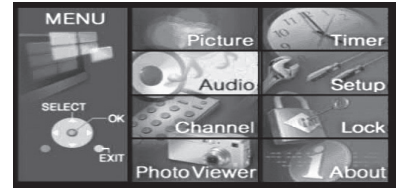

2

Press to select each item.

Note:
Normal is displayed at default.

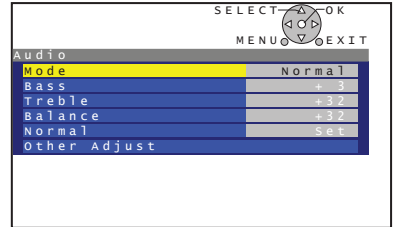

3 ■ **Mode:**

Press repeatedly to select Mode.

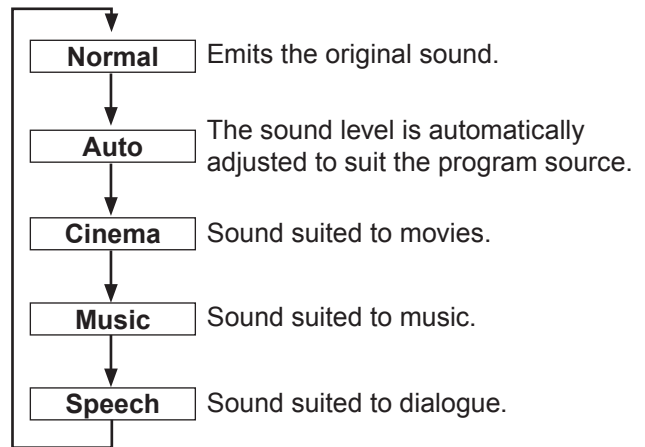

- **Bass:**
Increase or decrease the bass response.
- **Treble:**
Increase or decrease the treble response.
- **Balance:**
Emphasize the left/right speaker volume.

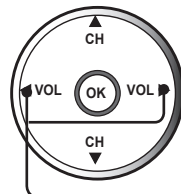

Adjust to desired level while viewing picture through the menu overlay.
Press MENU or wait a few seconds to return to the previous menu screen



Continued on the next page.

Other Adjust

While in the Audio menu screen, select Other Adjust and press OK to display the Other Adjust sub-menu.

■ Speaker:

This feature is used to turn TV speakers On or Off.

- On - TV speakers operate normally.
- Off - TV speakers off.

■ Surround:

Enhances audio response when listening to stereo.

■ Audio Select:

Perform input switching of analog audio input and digital audio input when using the HDMI terminal.

AUTO : Automatically performs digital/analog input switching according to the input signal type.

D in (digital) : Forces use of digital audio input signal transmitted via the HDMI terminal.

A in (analog) : Forces use of analog audio input signal transmitted via separate RCA terminals.

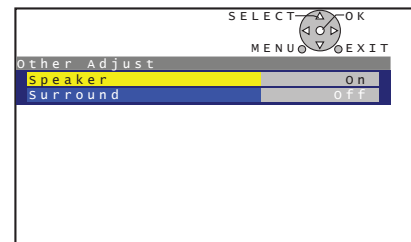
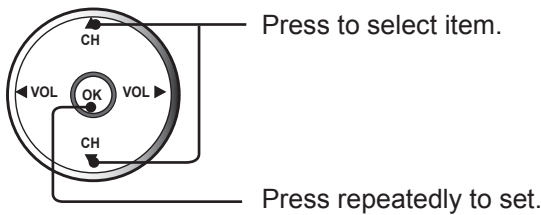

HDMI IN input

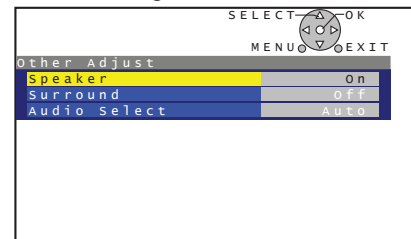

4



Press to exit menu.

Using BBE



BBE sound technology enhances speech intelligibility and restores the dynamic range of musical passages to provide outstanding natural sound.

Note:

If BBE is ON, Surround cannot be selected.

Notes:

- Sound signals are output from the rear AUDIO OUT and DIGITAL AUDIO OUT terminal. (See pages 20-21)
- When volume is adjusted or the MUTE button is pressed from the Remote Control, a message will be displayed.
- If the Mode is set to Auto, or if BBE is ON, Bass and Treble cannot be adjusted.

Lock Feature

This Device Display incorporates V-CHIP technology to block the viewing of movies and television programs according to the rating category. There are four (4) Content Advisory Categories: MPAA (Motion Picture Association of America), TV Parental Guidelines Ratings, Canadian English Language Ratings and Canadian French Language Ratings. These categories are used as guidelines for blocking the programs. The default mode for the Lock category is the Unlocked state. In this state, you can surf the various categories of the Lock menu. After you have created a password, you are prompted to enter it before you can make any changes in the Lock menu.

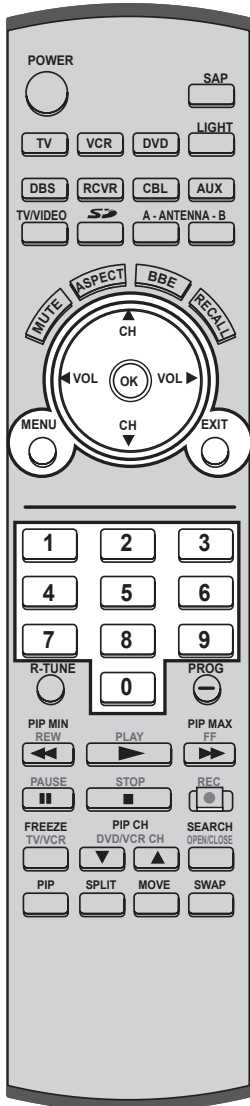

Enter Secret Code

A 4-digit code must be entered to view a blocked program or change rating settings.

Press MENU to display the Main Menu screen.

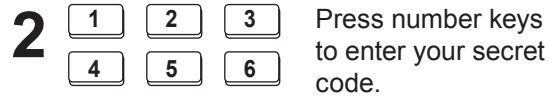
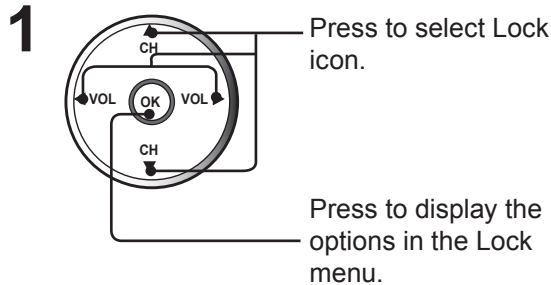

Note:
Use a code that is easy to remember and record it in a safe place.

Upon entering the 4 digit code, the Lock menu is displayed.

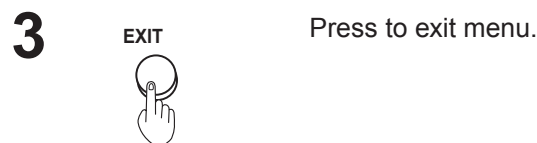

Notes:

- Once ratings are set, restricted tapes or programs cannot be accessed unless the secret code is entered.
- If you forget your secret code, refer to "Reset User's Memory Functions" on page 64.

Lock Set

Press MENU to display the Main Menu screen.

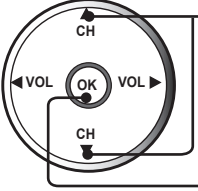
1  Press to select Lock icon.

Press to display the options in the Lock menu.

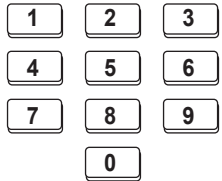

2  Press number keys to enter your secret code.

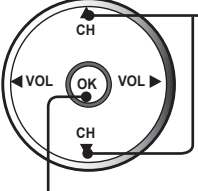

3  Press to select the Lock Set icon.

Press to display the Lock Set menu.

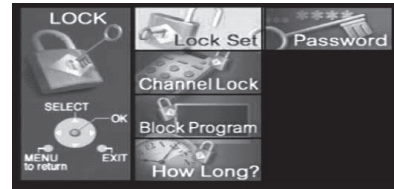

4 ■ **Mode:** To prevent video games, VCR tapes and all channels and video modes from being viewed. The possible modes are:

- Off - Turns off Lock set functions.
- Lock All - All channels are locked regardless of the rating level.
- Game Lock - Locks out CH 3, 4 and Video inputs.
- Channel Lock - Locks out specific analog and digital channels. Password is required to view any of the locked channels.

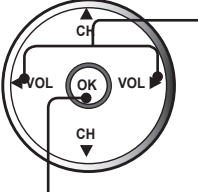
 Press to select the desired setting.

Press to set.



5  Press to exit menu.

Lock Feature



Channel Lock

This option lets you block out up to four (4) channels from each RF input (Antenna (A) and (B)) regardless of the program rating. Password is required to view these blocked channels.

Press MENU to display the Main Menu screen.

1 Press to select Lock icon.

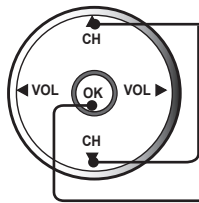

Press to display the options in the Lock menu.



2 Press number keys to enter your secret code.

3 Press to select the Channel Lock icon.

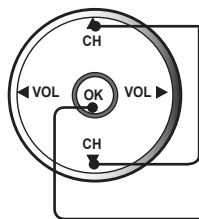

Press to display the Channel Lock menu.

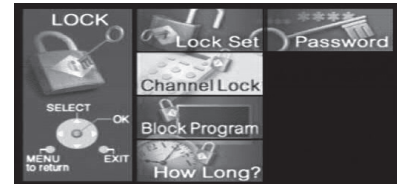

4 ■ **RF Input:**
Select either Antenna (A) or Antenna (B).

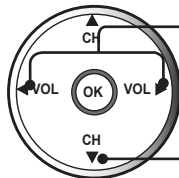

Press to select Antenna (A) or (B).

Press to select Channel.

5 ■ **Channel:**
Select up to 4 channels to be blocked out regardless of program rating.

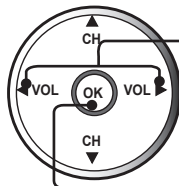

Press to select desired channel.

Press to enter your selection.

Up to 4 channels can be blocked, regardless of ratings, from each input.



6 EXIT
Press to exit menu.



Note:

To remove a channel number from the list, select that number and press OK button.

Block Program

This feature allows you block movies and television programs based on the MPAA, U.S. TV Ratings system, Canadian English Language Ratings and Canadian French Language Ratings.

■ MPAA:

The MPAA uses standard movie ratings to block unwanted movies from being displayed.

Press MENU to display the Main Menu screen.

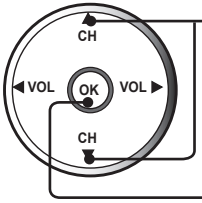
1  Press to select Lock icon.

Press to display the options in the Lock menu.

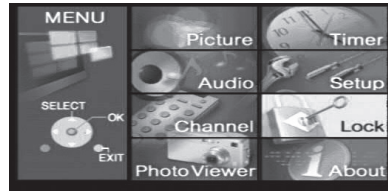

2 Press number keys to enter your secret code.

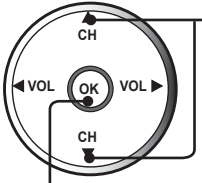

3  Press to select the Block Program icon.

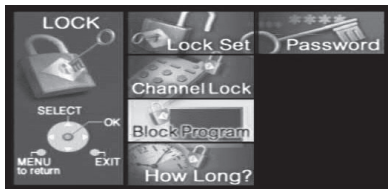
Press to display the Block Program menu.

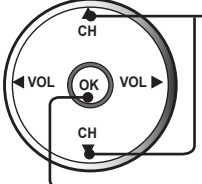

4  Press to select MPAA.

Press to enter the MPAA field.

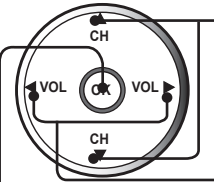

Block Program			SELECT  OK
MPAA	Mode	off	MENU to return  EXIT
U.S.TV	NR	Viewable	
C.E.L.R	G	Viewable	
C.F.L.R	PG	Viewable	
	PG-13	Viewable	
	R	Viewable	
	NC-17	Viewable	
	X	Viewable	

5 ■ Mode:
Off: Cannot view NR (not rated) programs.
On: Can view NR programs.

 Press to select Mode.



Press to select On or Off.

Press to set.

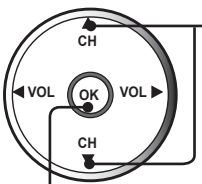
Block Program			SELECT  OK
MPAA	Mode	On	CHANGE  OK MENU to return  EXIT
U.S.TV	NR	Viewable	
C.E.L.R	G	Viewable	
C.F.L.R	PG	Viewable	
	PG-13	Viewable	
	R	Viewable	
	NC-17	Viewable	
	X	Viewable	

6  Press to select the desired rating level. (See page 65.)

Press to change the rating limit to "Viewable" or "Blocked".

Block Program			SELECT  OK
MPAA	Mode	On	MENU to return  EXIT
U.S.TV	NR	Viewable	
C.E.L.R	G	Viewable	
C.F.L.R	PG	Viewable	
	PG-13	Blocked	
	R	Blocked	
	NC-17	Blocked	
	X	Blocked	

7  Press to exit menu.

Lock Feature

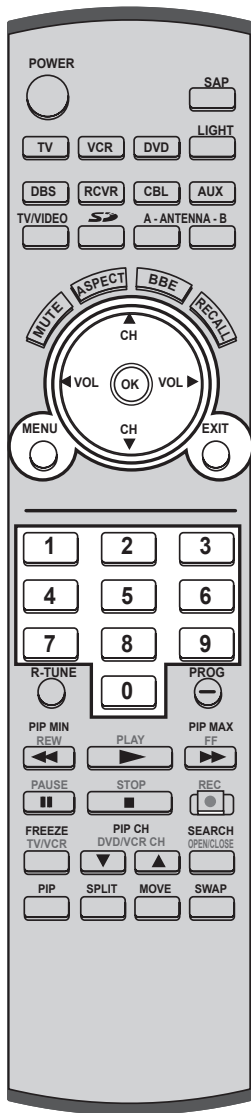

Block Program (Continued).

U.S. TV Rating

The TV Parental Guidelines has 7 levels of age-based ratings that can be selected. These 7 levels are split into 2 age-based groups: Youth Age-based Ratings and Guidance Age-based Ratings. Some of these age-based ratings can also have content-based ratings, denoted as D (Dialog), L (Language), S (Sex) and V (Violence). (See page 65.)

1 Press number keys to enter your secret code.
In Lock menu, select Block Program and press OK to display the Block Program menu.

2 Press to select U.S.TV.
Press to enter the U.S.TV field.

Block Program			SELECT OK
MPAA	Mode	off	MENU TO RETURN EXIT
U.S.TV	TV-NR	Viewable	
C.E.L.R	TV-Y	Viewable	
C.F.L.R	TV-Y7	FV	
	TV-G	Viewable	
	TV-PG	D L S V	
	TV-14	D L S V	
	TV-MA	D L S V	

3 **Mode:**
Off: Cannot view NR programs.
On: Can view NR programs.

Press to select Mode.
Press to select On or Off.
Press to set.

Block Program			SELECT OK
MPAA	Mode	on	CHANGE MENU TO RETURN EXIT
U.S.TV	TV-NR	Viewable	
C.E.L.R	TV-Y	Viewable	
C.F.L.R	TV-Y7	FV	
	TV-G	Viewable	
	TV-PG	D L S V	
	TV-14	D L S V	
	TV-MA	D L S V	

4 Press to select the desired rating level. (See page 65.)

Block Program			SELECT OK
MPAA	Mode	on	CHANGE MENU TO RETURN EXIT
U.S.TV	TV-NR	Viewable	
C.E.L.R	TV-Y	Viewable	
C.F.L.R	TV-Y7	FV	
	TV-G	Viewable	
	TV-PG	D L S V	
	TV-14	D L S V	
	TV-MA	D L S V	

Press to change the rating limit to "Viewable" or "Blocked".

Notes:

- The ratings, such as TV-PG, TV-14 and TV-MA have content level ratings also. These content levels can be individually blocked. Select the rating level, press VOL ► to select the desired content level and press the OK button to block.
- The TV-NR rating is independent of other ratings.
- If TV-Y is blocked, both TV-Y and TV-Y7 will be blocked. However, if you select TV-Y7, the FV setting can be blocked or unblocked.

5 Press to exit menu.

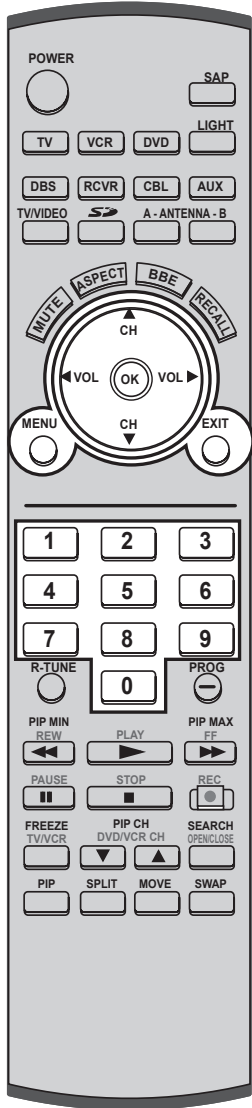

Block Program (Continued).

Canadian English Language Ratings

The V-CHIP used in this TV model allows you to block various types of movies and television programs based on the two rating systems used in Canada.

1 Press number keys to enter your secret code.
In Lock menu, select Block Program and press OK to display the Block Program menu.

2 Press to select C.E.L.R.

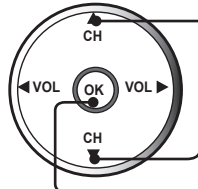

Press to select C.E.L.R.

Block Program			SELECT OK
MPAA	Mode		MENU to return EXIT
U.S.T.V	E	Viewable	
C.E.L.R	C	Viewable	
C.F.L.R	C8+	Viewable	
	G	Viewable	
	PG	Viewable	
	14+	Viewable	
	18+	Viewable	

Press to enter the C.E.L.R field.

3 **Mode:**
Off: Cannot view E (Exempt) programs.
On: Can view E (Exempt) programs.

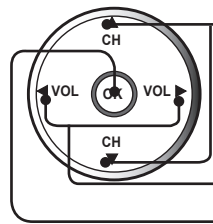

Press to select Mode.

Block Program			SELECT OK
MPAA	Mode		CHANGE MENU to return EXIT
U.S.T.V	E	Viewable	
C.E.L.R	C	Viewable	
C.F.L.R	C8+	Viewable	
	G	Viewable	
	PG	Viewable	
	14+	Viewable	
	18+	Viewable	

Press to select On or Off.

Press to set.

4 Press to select the desired rating level.
(See page 65.)

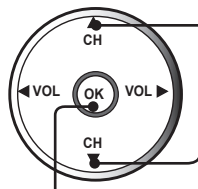

Press to change the rating limit to "Viewable" or "Blocked".

Block Program			SELECT OK
MPAA	Mode		CHANGE MENU to return EXIT
U.S.T.V	E	Viewable	
C.E.L.R	C	Viewable	
C.F.L.R	C8+	Blocked	
	G	Blocked	
	PG	Blocked	
	14+	Blocked	
	18+	Blocked	

5 **EXIT** Press to exit menu.



Lock Feature

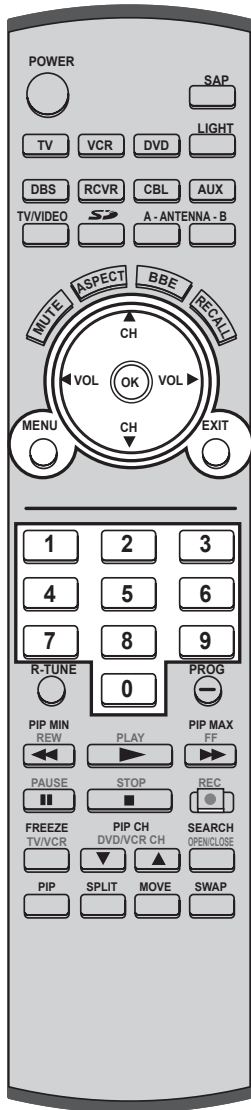

Block Program (Continued).

Canadian French Language Ratings

The V-CHIP used in this TV model also lets you block or unblock Canadian French programs according to various ratings categories.

1 Press number keys to enter your secret code. In Lock menu, select Block Program and press OK to display the Block Program menu.

2 Press to select C.F.L.R. Press to enter the C.F.L.R. field.

Block Program			SELECT OK
MPAA	Mode	off	MENU TO RETURN EXIT
U.S. TV	E	Viewable	
C.E.L.R.	G	Viewable	
C.F.L.R.	8 ans+	Viewable	
	13 ans+	Viewable	
	18 ans+	Viewable	

3 **Mode:**
Off: Cannot view E (Exempt) programs.
On: Can view E (Exempt) programs.

Press to select Mode. Press to select On or Off. Press to set.

Block Program			SELECT OK
MPAA	Mode	On	CHANGE MENU TO RETURN EXIT
U.S. TV	E	Viewable	
C.E.L.R.	G	Viewable	
C.F.L.R.	8 ans+	Viewable	
	13 ans+	Viewable	
	18 ans+	Viewable	

4 Press to select the desired rating level. (See page 65.)

Block Program			SELECT OK
MPAA	Mode	On	CHANGE MENU TO RETURN EXIT
U.S. TV	E	Viewable	
C.E.L.R.	G	Viewable	
C.F.L.R.	8 ans+	Viewable	
	13 ans+	Blocked	
	18 ans+	Blocked	

Press to change the rating limit to "Viewable" or "Blocked".

5 EXIT Press to exit menu.



How long?

This feature allows you lock the television input sources for a specific period of time. Available selections are: 12 hours, 24 hours, 48 hours or Always.

Press MENU to display the Main Menu screen.

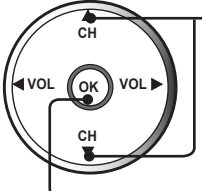
1  Press to select Lock icon.

Press to display the options in the Lock menu.

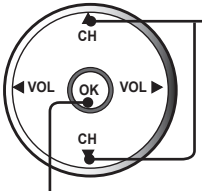

2 Press number keys to enter your secret code.

3  Press to select the How Long? icon.

Press to display the How Long? menu.

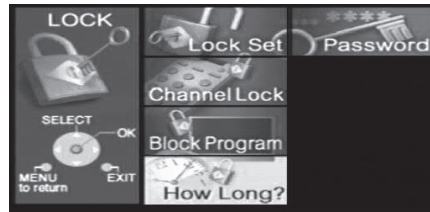

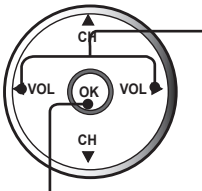
4  Press to select Time.

Press to set.

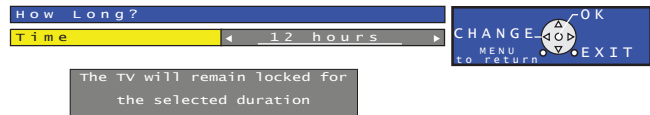

5  Press to exit menu.

Password

You can change your 4 digit password.

Press number keys to enter your secret code.

In Lock menu, select Password and press OK to display the Change Password menu.

Press number keys to enter a new 4 digit password.



Lock Feature

Blocking Messages

Various Blocking messages are displayed on-screen depending upon the type of blocking you have selected in the Lock menu.

When Game Lock or Channel Lock is selected:

Following message is displayed if you attempt to tune to channels or select video.

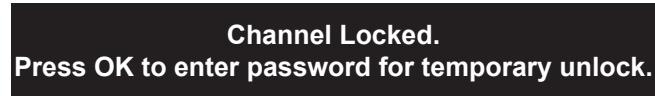

When the rating level is exceeded

Following message is displayed if the program you are viewing exceeds the set rating level. To view a blocked program, you must enter your password.

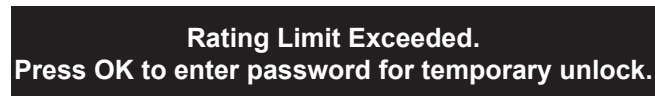

Note:

Entering the password will override the block condition. However, the ratings selection will be retained.

Reset User's Memory Functions

Use when moving unit to a new location, or if the secret password is forgotten.

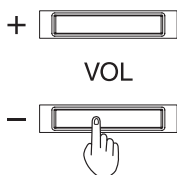

Procedure

Press the VOL- button on the unit and OK button on the Remote control at same time for more than 5 seconds. When reset is finished, power shuts off automatically.

And

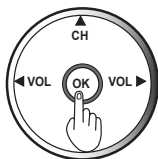

US MOVIES RATINGS:

NR	Not Rated by MPAA.
G	GENERAL AUDIENCES. All ages admitted.
PG	PARENTAL GUIDANCE SUGGESTED. Some material may not be suitable for children.
PG-13	PARENTS STRONGLY CAUTIONED. Some material may be inappropriate for children under 13.
R	RESTRICTED. Under 17 requires accompanying parent or adult guardian.
NC-17	NO ONE 17 AND UNDER ADMITTED.
X	ADULTS ONLY.

US TV PROGRAMS RATINGS: Chart 1

Age-based Group	Age-based Ratings	Possible Content Selections
NR (Not Rated)	TV-NR	<ul style="list-style-type: none"> Viewable Blocked
Youth	TV - Y	<ul style="list-style-type: none"> Viewable Blocked
	TV - Y7	<ul style="list-style-type: none"> FV (Fantasy Violence) Viewable Blocked
Guidance	TV - G	<ul style="list-style-type: none"> Viewable Blocked
	TV - PG	<ul style="list-style-type: none"> D, L, S, V (all selected) Any combination of D, L, S, V
	TV - 14	<ul style="list-style-type: none"> D, L, S, V (all selected) Any combination of D, L, S, V
	TV - MA	<ul style="list-style-type: none"> L, S, V (all selected) Any combination of L, S, V

US TV PROGRAMS RATINGS: Chart 2

TV-NR	Not Rated.
TV-Y	All Children. The themes and elements in this program are specifically designed for a very young audience including children from ages 2-6.
TV-Y7	Directed to older children. Themes and elements in this program may include mild physical or comedic violence or may frighten children under the age of 7.
TV-G	General Audience. It contains little or no violence, no strong language, and little or not sexual dialogue or situations.
TV-PG	Parental guidance suggested. The program may contain infrequent coarse language, limited violence, some suggestive sexual dialogue and situations.
TV-14	Parents strongly cautioned. This program may contain sophisticated themes, sexual content, strong and explicit sexual content.
TV-MA	Mature Audiences only. This program may contain mature themes, profane language, graphic violence and explicit sexual content.
FV	Fantasy/Cartoon Violence.
V	Violence
S	Sex
L	Offensive Language
D	Dialogue with sexual content.

Canadian English Language Ratings Chart

C	Children
C8+	Children 8 years and older
G	General Audience
PG	Parental Guidance
14+	Viewers 14 years and older
18+	Adult Programming

Canadian French Language Ratings Chart

G	General Audience
8 ans+	Not recommended for young children
13 ans+	Programming may not be suitable for children under the age of 13
16 ans+	Programming is not suitable for children under the age of 16
18 ans+	Adults only

Closed Caption Feature

The Device Display includes a built-in decoder capable of visually displaying the audio portion of broadcasts which feature Closed Captioning (CC). You can set your preferences for both digital and analog Closed Captioning.



Notes:

- The closed caption or text signal may be broadcast over C1, C2, or both. Also, text contents can vary so you may wish to try different settings.
- Closed Caption is not displayed if the input signal is COMPONENT VIDEO INPUT of 480p or more, or from RGB IN.

CC Mode

Activates the On-Screen Closed Caption feature. When activated this feature will remain on until OFF is selected in this menu.

Press MENU to display the Main Menu screen.

1 Press to select Setup icon.

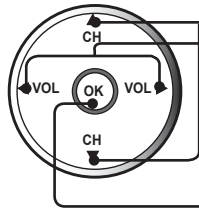

Press to display the options in the Setup menu.



2 Press to select Closed Caption icon.

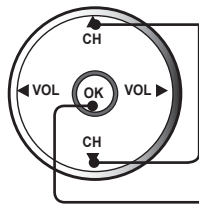

Press to display the Closed Caption menu.

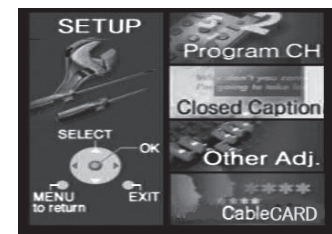

3 Press to select CC Mode.

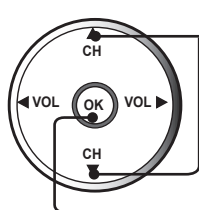

Press to enter the CC Mode field.

4 Press to select desired setting.

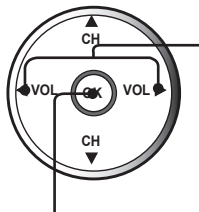

- Off - No display.
- On - Display when available.
- On Mute - Display when audio is muted.

Press to set.



5 Press to exit menu.



Closed Caption Feature

Analog

This option lets you choose the closed caption service you desire.

1 In Closed Caption menu, select Analog.

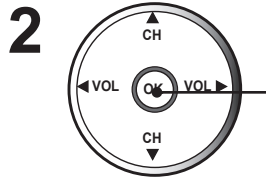

Press to select the desired setting: CC1, CC2, CC3, CC4, T1, T2, T3 or T4.



CC1 - For video related information that can be displayed (up to 4 lines of script on the screen where it does not obstruct relevant parts of the picture). Script can be in any language.

CC2 to CC4 - Other modes used for video related information.

T1 - Blanks out a large portion of the picture on the television screen, and displays program guide or any other information currently being transmitted.

T2, T3, and T4 - Other modes that display information and blank out a large portion of the picture.

Digital

The Digital Closed Captioning menu allows you to select the way in which you view digital captioning. You can choose the type of closed captioning service, font type, font size, and font style. The colors sub-menu lets you set the color of the font (foreground), text box (background) on which the text is displayed, the font opacity (Fore Opacity), text box opacity (Back Opacity), and the outline of the dropshadow (if selected under style).

1 In Closed Caption menu, select Digital.

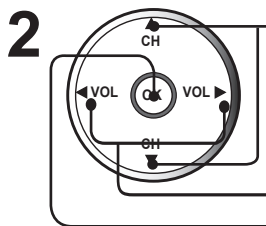

Press to select each item.

Press to select desired setting.

Press to set.

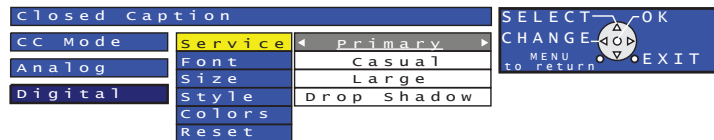

Service:

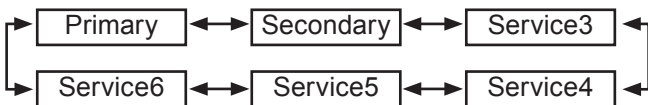

Font:

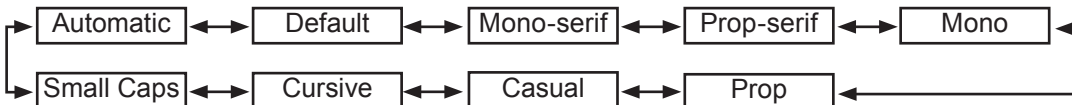

Continued on the next page.

Closed Caption Feature



Note:

When digital caption is used on digital channel, the VIDEO OUT will also output the CC information. This means, if you tape the program, the CC information will also be recorded on tape. To avoid this, either turn off digital CC or turn on analog CC.

Continued from page 67.

Size:

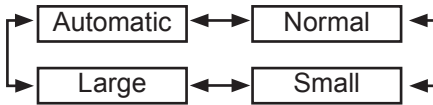

Style:

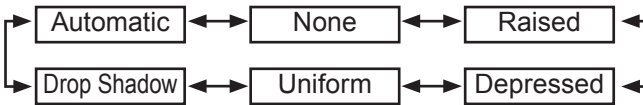

Colors:

1 In digital closed captioning sub-menu, select Colors and press OK to display the colors sub-menu.

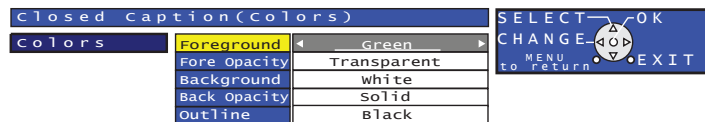
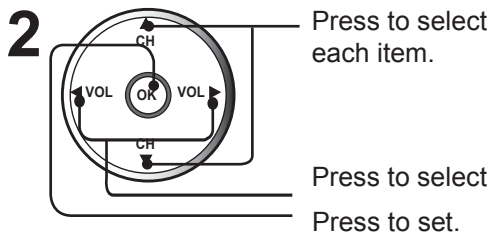

Foreground



Fore Opacity

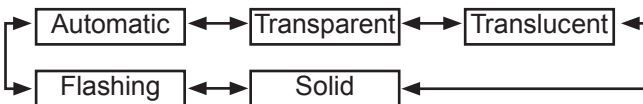

Background



Back Opacity

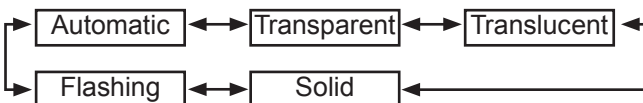

Outline



Channel Caption Feature

To enter preset and manual labels for desired stations. Also, to enter input labels for video inputs.



■ Preset Labels:

To enter channel numbers for popular TV stations.
Press MENU to display the Main Menu screen.

1 Press to select Channel icon.

Press to display the options in the Channel menu.



2 Press to select Captions icon.

Press to display the Captions menu.



3 Press to select Preset Labels.

Press to enter Preset Labels listed.

Captions		SELECT	OK
Preset Labels	RF Input	Antenna (A)	MENU to return EXIT
Manual Labels	ABC		
	CBS		
	FOX	A: 2-3	
Input Labels	NBC		
	PBS		
	CNN		
	ESPN		
	HBO		

4 In the RF Input field, select either Antenna (A) or Antenna (B).

Note:

Only input with signal will be selectable.

5 Press to set.

Press to select desired preset caption.

6 Press OK to enter the selection. Then use the remote number keys to select desired channel (refer to your local TV guide).

Note:

To delete a channel number, while selected press ◀ VOL repeatedly until all numbers are removed.

7 Press to exit menu.

Channel Caption Feature (Continued)



Manual Labels:

To enter numbers and captions manually.

1 In Channel menu, select Caption and press OK to display the Caption menu.

2 Press to select Manual Labels.

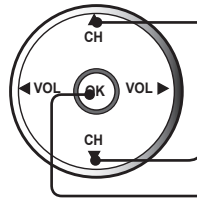

Press to enter Manual Labels listed.

Captions			SELECT OK
Preset Labels	RF Input	Antenna (A)	MENU RETURN EXIT
Manual Labels	Channel	A: 2-3	
Input Labels	Caption	FOX	

3 Press to select RF Input.

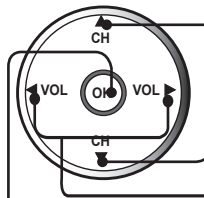

Press to select Antenna (A) or Antenna (B).
Press to set.

Note:
Only input with signal will be selectable.

4 Press to select Channel.

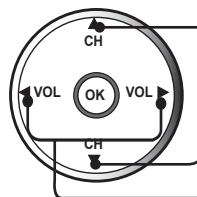

Press to select available channel number.

5 Press to select Caption.

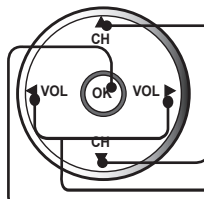

Press to select first character position.
Press to set.

6 Press to select character (refer to your local TV guide for labeling channels).

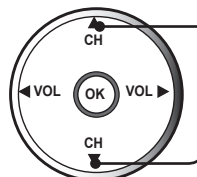

Continued on the next page.

Channel Caption Feature (Continued)

7 Repeat 4, 5, and 6 until all captions are added. Up to (7) characters per channel.

8 Use the remote number keys to select desired channel.

Note:

To delete the Channel Caption, highlight the first character and press CH ▲ or CH ▼ until no character is displayed. Move to the next character and repeat the process. After all characters have been deleted, press OK to enter the choice.

9  Press to exit menu.

■ Input Labels:

To label video input connections for onscreen display.

1 In Channel menu, select Caption and press OK to display the Caption menu.

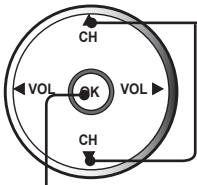
2  Press to select Input Labels.

Captions		
Preset Labels	Component 1	PVR
Manual Labels	Component 2	DVD
Input Labels	Component 3	SKIP
HDMI		
	Video 1	VCR
	Video 2	GAME
	Video 3	SKIP
	PC/RGB1	
	PC/RGB2	

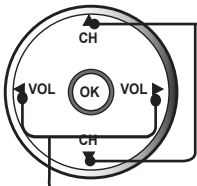

Press to enter Input Labels listed.

3  Press to select inputs.

Press to select preset Input Labels for inputs.

Input Labels that are set to SKIP cannot be selected when changing input modes with the TV/VIDEO button, etc.

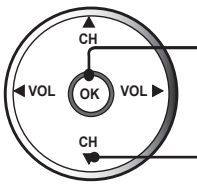
4  Press to set.

Press to select another input, then repeat procedure for adding more labels to inputs.

Notes:

- To delete Input labels, select desired input, then press the ◀ VOL or VOL ▶ buttons until no label is displayed. Press the OK button to enter your selection.

5  Press to exit menu.

Color Temp Feature

To increase or decrease Warm (red) and Cool (blue) colors to suit personal preferences.



Press MENU to display the Main Menu screen.

1 Press to select Picture icon.

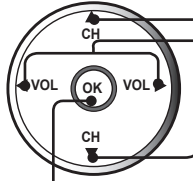

Press to display Picture menu.

2 Press to select Other Adjust.

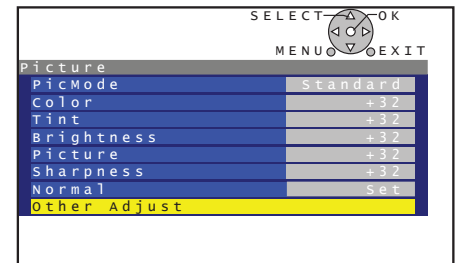
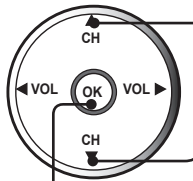

Press to display the Other Adjust sub-menu.

3 Press to select Color Temp.

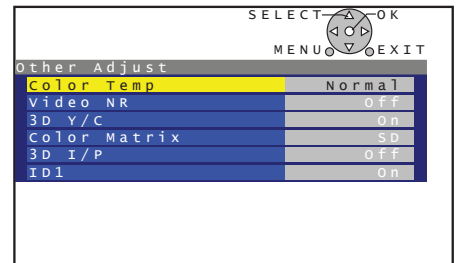
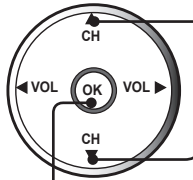

Press to set .

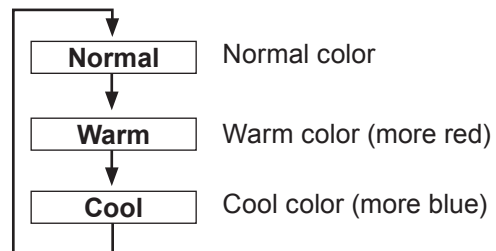

4



Press to exit menu.

Note:

During RGB input, Color Temp changes to Normal.

Video NR (Noise Reduction) Feature

In the event of weak signal conditions, the Video NR circuitry reduces noise in the luminance channel. It is important to note that Video NR should remain Off for maximum picture detail when receiving a strong signal or viewing high-quality video.



Note:
When an RGB signal is input, Video NR is set to Off only.

Press MENU to display the Main Menu screen.

1

Press to select Picture icon.

Press to display Picture menu.

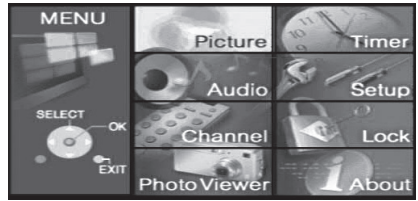

2

Press to select Other Adjust.

Press to display the Other Adjust sub-menu.

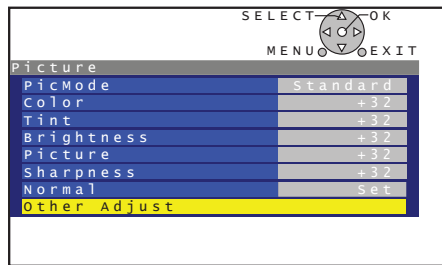

3

Press to select Video NR.

Press to set "On" or "Off".

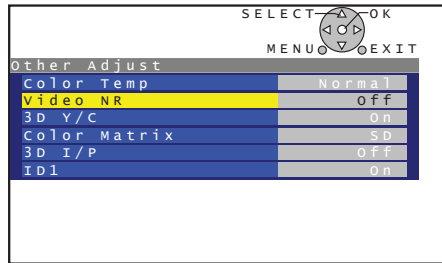

On: When signal is noisy
Off: When signal is high-quality

4

Press to exit menu.

3D Y/C Feature

Accurate separation of the picture's brightness and color signals allows you to enjoy a beautiful picture.



Press MENU to display the Main Menu screen.

1

Press to select Picture icon.

Press to display Picture menu.



2

Press to select Other Adjust.

Press to display the Other Adjust sub-menu.

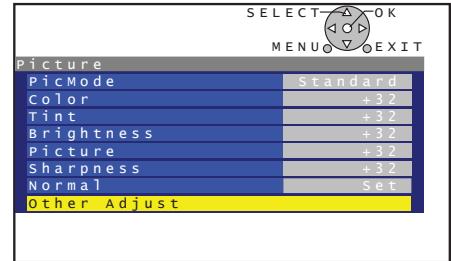

3

Press to select 3D Y/C.

Press to set "On" or "Off".

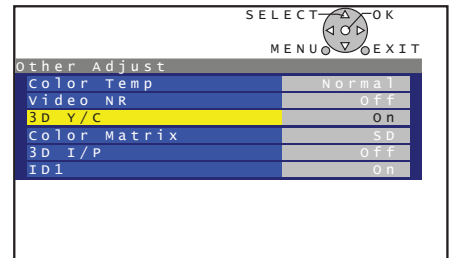

On: Usually set to On.
Off: Set to Off if picture appears unnatural.

4

Press to exit menu.

Setting when 480p signals are input through COMPONENT VIDEO INPUT

Adjust 480p signals to achieve a natural color from digital equipment connected to COMPONENT VIDEO INPUT (Y, PB, PR input terminals).



Press MENU to display the Main Menu screen.

1

Press to select Picture icon.

Press to display Picture menu.

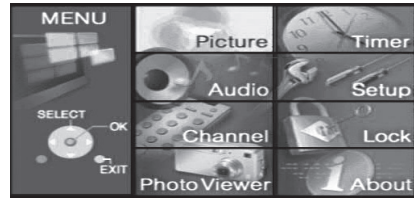

2

Press to select Other Adjust.

Press to display the Other Adjust sub-menu.

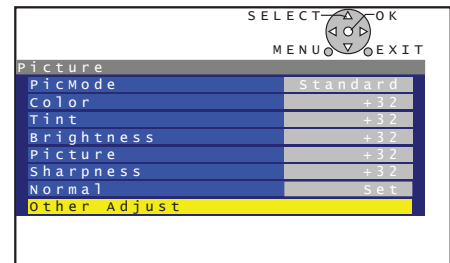

3

Press to select Color Matrix.

Press to set "SD" or "HD".

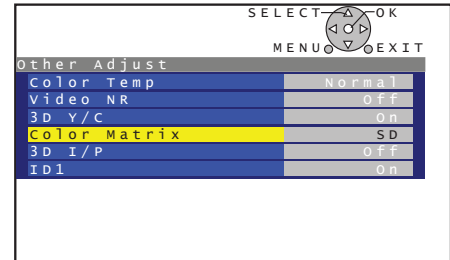

- SD: When the input signal is a normal TV system (NTSC).
- HD: When the input signal is a High-Definition system (HD).

4

Press to exit menu.

Note:

Color Matrix does not need to be set when using Hi-Definition equipment or 480i output equipment.

3D I/P Feature

Film media (taken at 24 frames per second) is faithfully reproduced on the Device Display.



Press MENU to display the Main Menu screen.

1

Press to select Picture icon.

Press to display Picture menu.

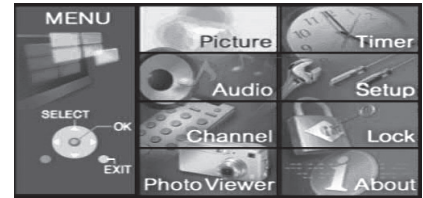

2

Press to select Other Adjust.

Press to display the Other Adjust sub-menu.

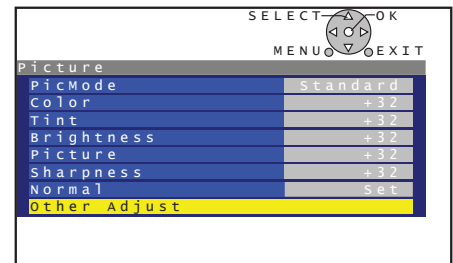

3

Press to select 3D I/P.

Press to set "On" or "Off".

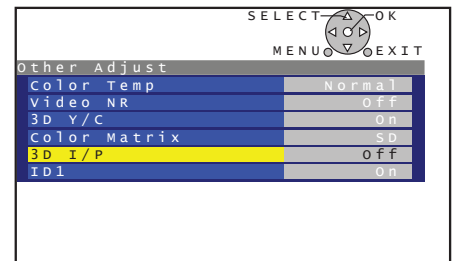

On: Recordings created at 24 frames per second are shown in higher quality.

Off: Set to Off if picture appears unnatural.

4

EXIT Press to exit menu.

Automatically changing screen size

If the received signal contains screen size specifications in RF, VIDEO INPUT (1–3) or COMPONENT VIDEO INPUT (1–3), the screen size is automatically changed.



Press MENU to display the Main Menu screen.

1 Press to select Picture icon.

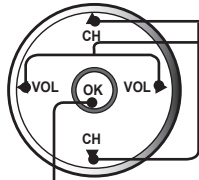

Press to display Picture menu.

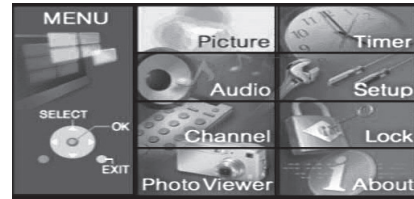

2 Press to select Other Adjust.

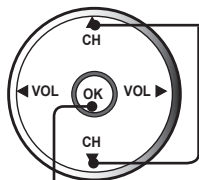

Press to display the Other Adjust sub-menu.

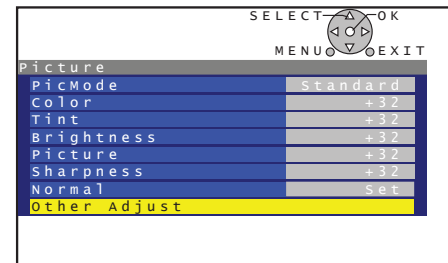

3 Press to select ID1.

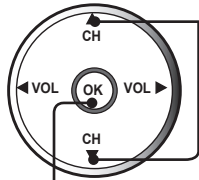

Press to set "On" or "Off".

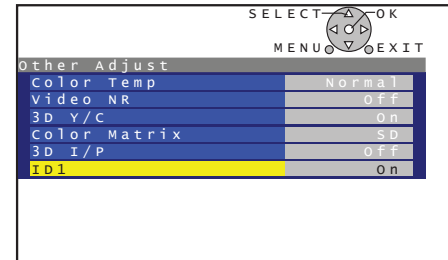

- On: When screen size specification signals are detected, screen size is automatically changed.
- Off: The screen size is not automatically changed. (Turn Off if this function does not operate properly.)

4 Press to exit menu.



Notes:

- When ID1 is detected and screen size is changed, Aspect mode will be displayed.
- When displaying split screen, ID1 is not detected.

RGB IN Input Feature

Set the signal to be input to the Device Display's RGB IN terminal. Most analog RGB IN signals are selected automatically. When RGB input signal is VGA 60Hz from PC or 480p from other equipment, you must manually switch to the desired input.



Press MENU to display the Main Menu screen.

1

Press to select Picture icon.

Press to display Picture menu.



2

Press to select Other Adjust.

Press to display the Other Adjust sub-menu.

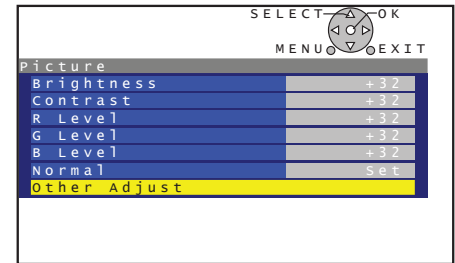

3

Press to select desired RGB input.

Press to set "VGA" or "480P".

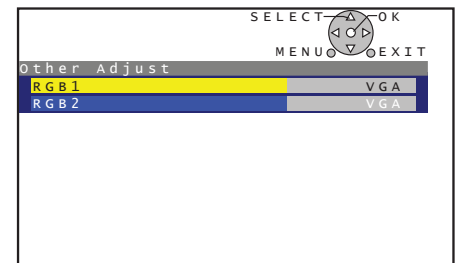

VGA : When RGB input signal is VGA 60Hz from PC.
 480P : When RGB input signal is 480P from other equipment.

4

Press to exit menu.

Sleep Timer Feature

The Device Display can be set to shut itself off at a preselected time.



Press MENU to display the Main Menu screen.

1

Press to select Timer icon.

Press to display Timer menu.

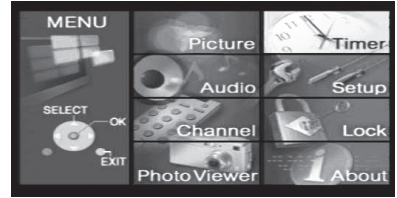

2

Press repeatedly to select the desired time.

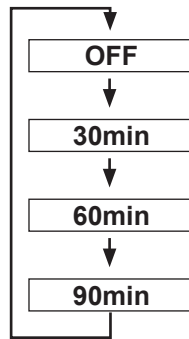
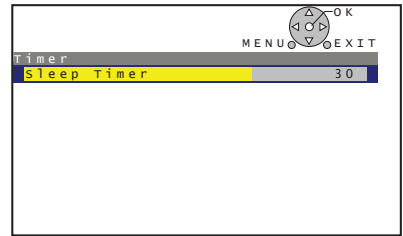

3

EXIT

Press to exit menu.

Notes:

- Pressing the RECALL button with sleep timer set displays remaining time.
- The on-screen display will flash 3, 2 and 1 to indicate the last three (3) remaining minutes prior to turn off.

Information

You can display the input signal type. Display items differ depending on the input signal.



Press MENU to display the Main Menu screen.

1

Press to select Setup icon.

Press to display the options in the Setup menu.

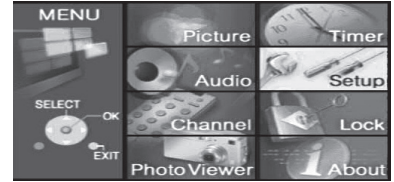

2

Press to select the Other Adj. icon.

Press to display the Other Adjustment menu.

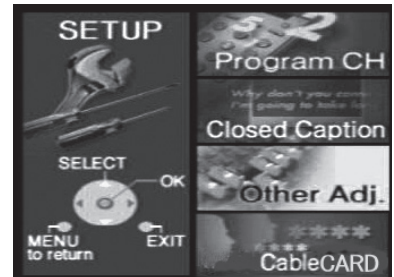

3

Press to select Information.

Press to display Information screen.

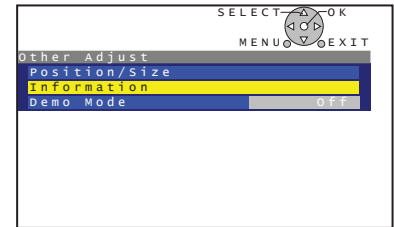

4

Press to exit menu.

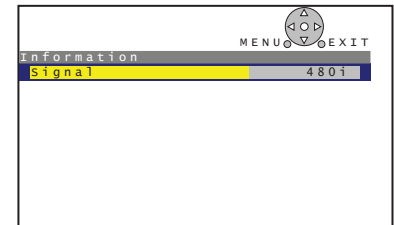

Demo Mode Feature

Function demonstrations of this unit are displayed in Demo Mode.

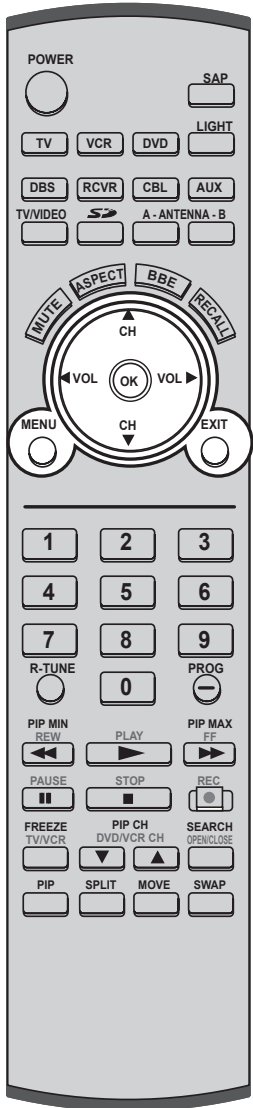

Press MENU to display the Main Menu screen.

1 Press to select Setup icon.

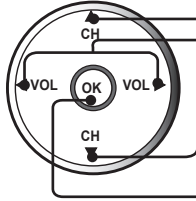

Press to display the options in the Setup menu.

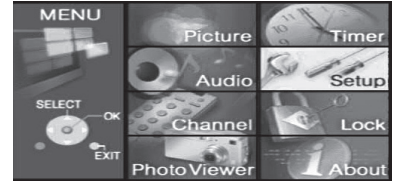

2 Press to select the Other Adj. icon.

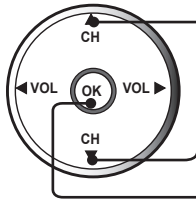

Press to display the Other Adjustment menu.

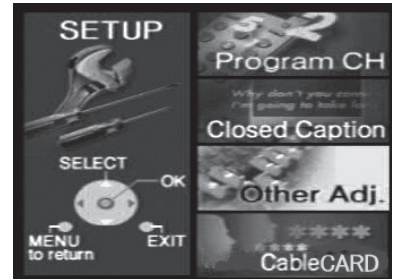

3 Press to select Demo Mode.

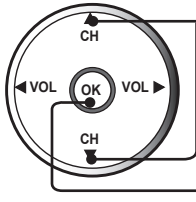

Press to set.

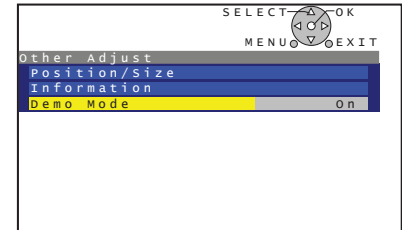

On: Demo Mode is started.
Off: Demo Mode is canceled.

4 Press to exit menu.

EXIT



Note:

Demo Mode setting remains even when power is turned off. To turn off Demo Mode, select Demo Mode : Off in the menu screen.

Signal Meter Feature

Displays the signal strength of the ATSC digital channel in either Antenna (A) or Antenna (B).



Press MENU to display the Main Menu screen.

1 Press to select Setup icon.

Press to display the options in the Setup menu.

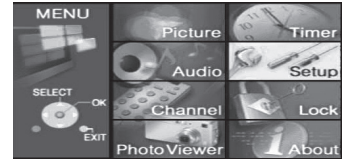

2 Press to select Program CH icon.

Press to display the Program Channel menu.

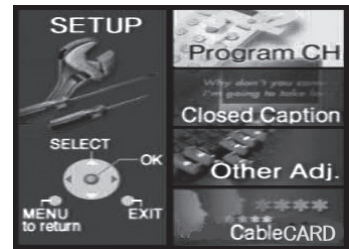

3 Press to select Signal Meter.

Press to enter sub-menu.

4 In the RF Input field, select either Antenna (A) or Antenna (B).

5 Press to select channel number.

Press to display the Signal Strength.

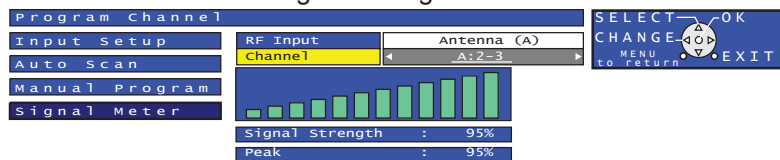

Note:

The color of the signal bar usually indicates the strength of the received signal.

- Green - Adequate signal for a good reception.
- Yellow - Poor signal strength.
- Red - Very poor signal strength. (If a strong signal is received, but has enough errors in the digital information, the signal bars will be in red.)

6 Press to exit menu.

Note:
Signal meter feature is not available for analog channels.

Switching languages for display

The language of the projection display is set to English as the factory setting.
To select one of 3 different languages for on-screen displays, follow the instructions below.



Press MENU to display the Main Menu screen.

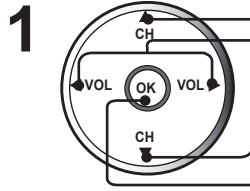

Press to select Setup icon.

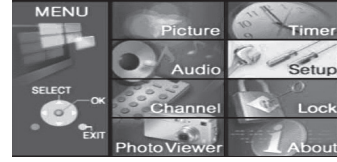

Press to display the options in the Setup menu.

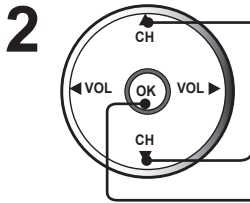

Press to select Program CH icon.

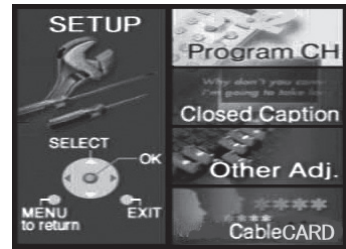

Press to display the Program Channel menu.

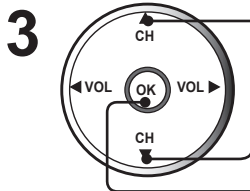

Press to select Language.

Press to enter sub-menu.

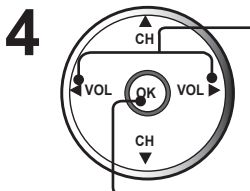
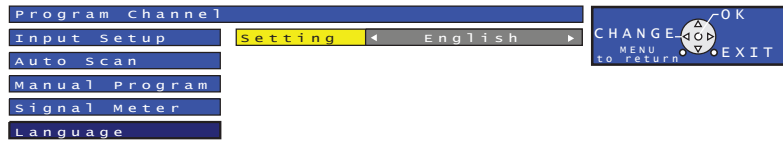

Press to select the desired Language.

Press to set.

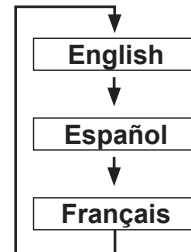

Press to exit menu.

Cable Module Info

This menu is used to provide information when a DCM (Digital Cable Module) is inserted into the DCM INTERFACE (POD INTERFACE) slot in the back of the projection television. If no DCM is present and you try to access the Cable Module Info, the message "Cable Module not present" will be displayed on screen. To receive the features offered by your cable company, you may have to subscribe to those services.



Press MENU to display the Main Menu screen.

1

Press to select Setup icon.

Press to display the options in the Setup menu.

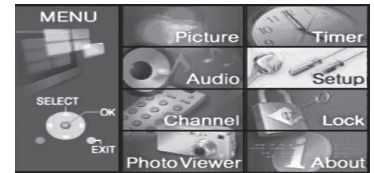

2

Press to select Cable Module Info.

Press to display the Cable Module Info.

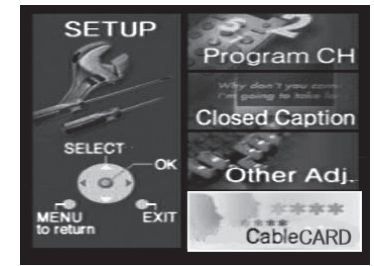

3

EXIT

Press to exit menu.

Note:

Please contact your cable company regarding availability of the DCM (Digital Cable Module). The cable module is needed to receive premium digital services (where available) through the cable input. You may also be able to order call-ahead pay per view events.

About Screen

The About screen displays assorted information about the Device Display. Please have this information when calling Customer Care Center.



Press MENU to display the Main Menu screen.

1

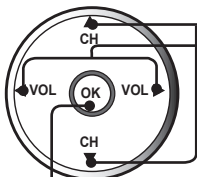

Press to select About icon.

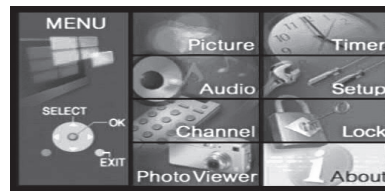

Press to display About menu.

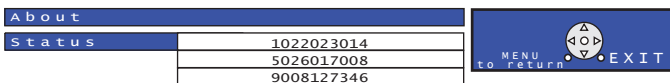

2

EXIT



Press to exit menu.

Photo Viewer (SD Card/PC Card)

Still image data (JPEG) made with a digital camera, digital video camera, or PC can be played back using an SD Card/PC Card.

⚠ WARNING

As with any small object, SD cards can be swallowed by young children. Do not allow children to handle the SD card.

Displayable Image Formats:

Baseline JPEG

(80 x 60 ~ 5 120 x 3 840 pixels)

Notes:

- Some parts of an image may not be displayed or the image may be displayed on a smaller scale depending on the size of the image.
- Only JPEG images can be displayed on this Device Display.

Card Data Protection

- Do not remove the card while it is being accessed.
- Do not touch the terminals on the back of the SD Card/PC Card.
- Electrical interference, electrostatic discharges and malfunctions of the unit or card may all result in damage to the card or data loss. It is recommended that any important data also be backed up on a PC.
- Stored data should be periodically backed up as a protection against data corruption, data loss or device malfunction. Please note that our company shall not accept any liability for damage or loss of stored data.

Caution

- Always insert card in the correct direction. Failure to do so may result in damage to the card and this unit.
- The SD Card and PC Card are precision devices. Do not subject them to excessive pressure or strong impacts.

Folders and Files

Digital cameras that are compliant with DCF specifications use folders with a specific structure. The following diagram shows an example of the folder structure.

Example:

If the Card file hierarchy is displayed on the PC as shown in diagram at below.

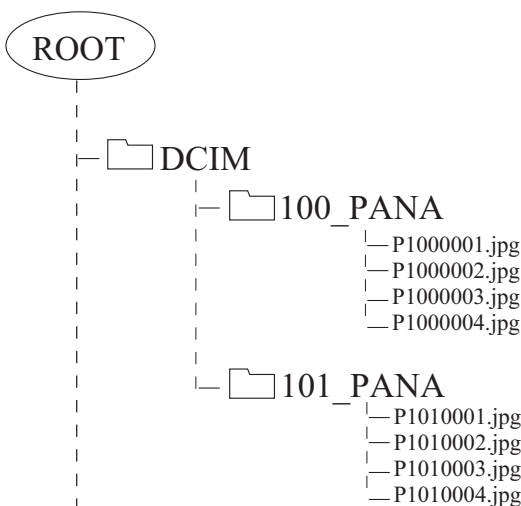

DCIM Folder

The digital camera creates this folder automatically.

100_PANA Folder

Folder names consist of a 3-digit folder number which is followed by five arbitrary characters. Digital camera images are stored within these folders.

JPEG files in the 100_PANA folder are displayed when a Card, which is structured as shown left, is inserted. To display another folder, see page 88 Index Area Operation.

Note:

The folder and file name may vary according to the digital camera being used.

P1000001.JPG: DCF File

File names consist of four arbitrary characters followed by a 4-digit file number. DCF files are image files (normally JPEG files) that have been taken by a digital camera.

Photo Viewer (SD Card/PC Card)

Insert the Card.

Front Card Slot (P. 12)

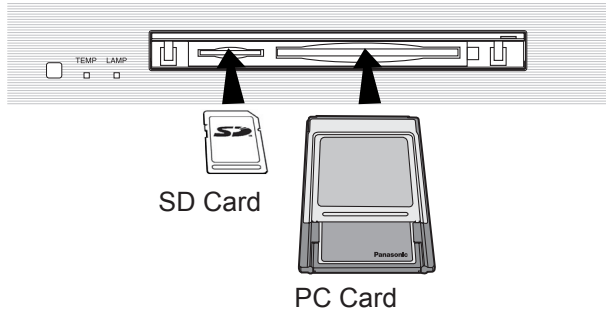

Remove the Card.

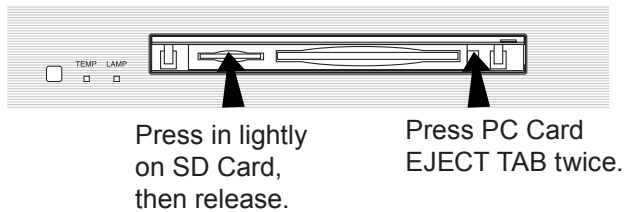

Compatible Card

SD Card slot	PC Card slot
SD Card	Compact Flash*
Multi Media Card	Smart Media*
	Memory Stick*
	xD Picture Card*

- The media* listed in the right column above can be read via the PC Card in the PC Card adaptor.
- Hard disk PC Cards, Flash ATA Cards, and other recorded media cannot be used.
- Place the selected media onto the PC Card and then insert into the PC Card Slot.
- When both an SD Card and PC Card are inserted, the SD Card contents has priority and will be displayed.
- If the Card is unusable, "CARD FORMAT NOT SUPPORTED" is displayed on-screen. Remove the Card only when ACCESS is not displayed.
- If an incompatible JPEG file is displayed (full size file preview), "DATA FORMAT NOT SUPPORTED" is displayed.

Notes:

- Insert/remove Card while "Card Menu Screen" or "No Card" is displayed.
- Be sure ACCESS is not displayed before Card insertion/removal.
- Fully insert the Card (ACCESS is displayed). Wait until ACCESS goes out before removing.
- Before reinserting a Card after removing it, wait until "NO CARD" is displayed. If there are Cards in both Card Slots, wait until the Card Menu Screen of the other Slot is displayed and ACCESS is no longer displayed before reinserting a Card.

Card Menu Screen

The screen below is displayed automatically when a card is inserted. If "NO CARD" appears, confirm that a card is correctly inserted.

Parent Folder
Returns currently displayed folder to the parent (previous) folder.

Subfolder
The subfolder of the currently displayed folder is opened.

Display Page No.
When the displayed files/folders fill more than one page, the total number of pages is displayed.

Index Area
Folders and files are displayed here.

Notes:

- Up to 1 000 JPEG files can be displayed. (This number may be lower if subfolders, or files other than JPEG are included in the folder.)
- Depending on JPEG file type, "JPEG" will be displayed instead of thumbnail image.

Note:
Only JPEG files can be displayed.

Menu Area
Select display method (SINGLE PLAY or SLIDE SHOW). Confirm the displayed card type (SD Card or PC Card).

ACCESS Indication
ACCESS is displayed while data is read.

Folder Name Area
The name of the selected subfolder (framed in yellow) is displayed.

Photo Viewer (SD Card/PC Card)

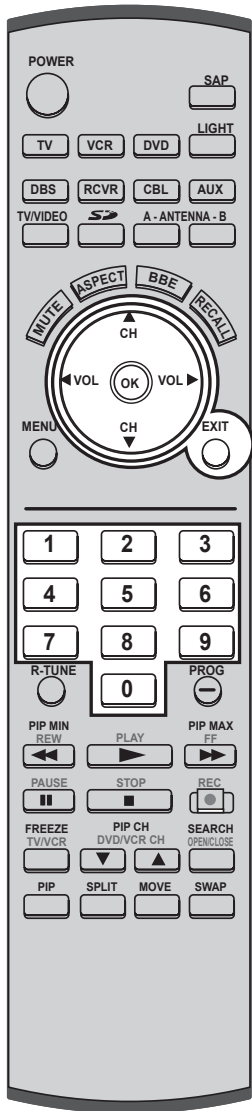

MENU Area Operation

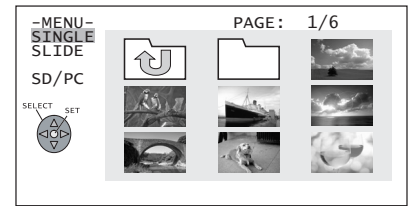
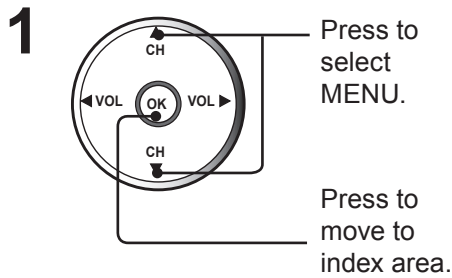

SINGLE

A single image selected from the index area fills the screen. You can also rotate the image and view image information. (PP. 89-90)

SLIDE

Images are displayed one after another as a slide show. Also, the SPEED and Transition features (p. 90) can be used.

SD/PC

When both an SD Card and PC Card are inserted, the ◀▶ buttons can be used to select a card in the index area.

Index Area Operation

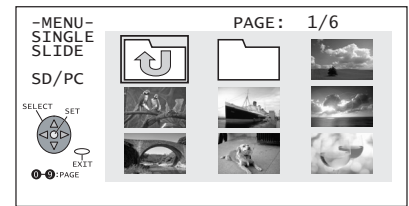
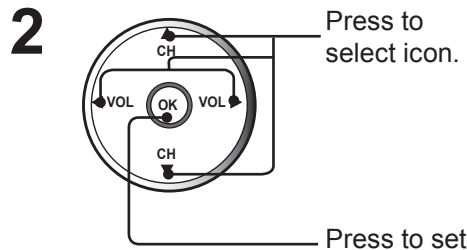

To select a page directly, enter the page number with the Number Keys, then press OK.

Select an Image file.

Display full size file preview.

Select a Subfolder (📁).

Display files/folders contained in the folder.

Select a Parent folder (🔙).

Make changes to the parent (previous) directory display.

Note:

File and folder names will not be displayed correctly if...

- More than 8 characters are used.
- Spaces and special symbols are used. Use care when changing file and/or folder names.

RETURN Operation

EXIT Press EXIT to display RETURN MENU.
Press ▲▼ to select an item, and press OK.



RETURN:
Returns to the parent (previous) folder.
RETURN TO MENU:
Returns to Menu Area screen.

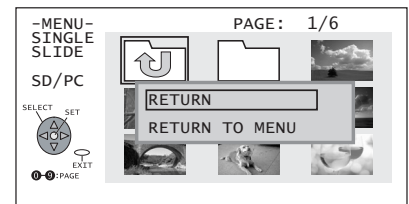
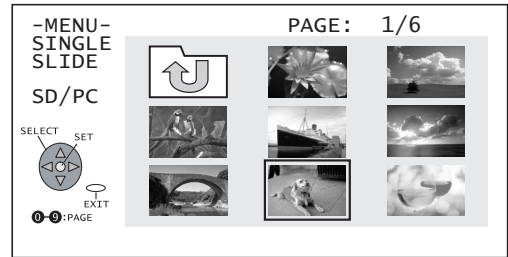

Photo Viewer (SD Card/PC Card)



Single Play Mode

- Press ▲▼ to select "SINGLE," and press OK.
 Press ▲▼◀▶ to move cursor to desired file in INDEX AREA.
 (Press ▲▼◀▶ to display next/previous page of 9 thumbnail files),
 Press OK to display file in full screen size.



SINGLE VIEW SCREEN

- Press ▶ : The next image is displayed.
- Press ◀ : The previous image is displayed.
- Press ▼ : Each press rotates image 90°.

Note:

When changing folders or images, the rotation setting is returned to the initial position.

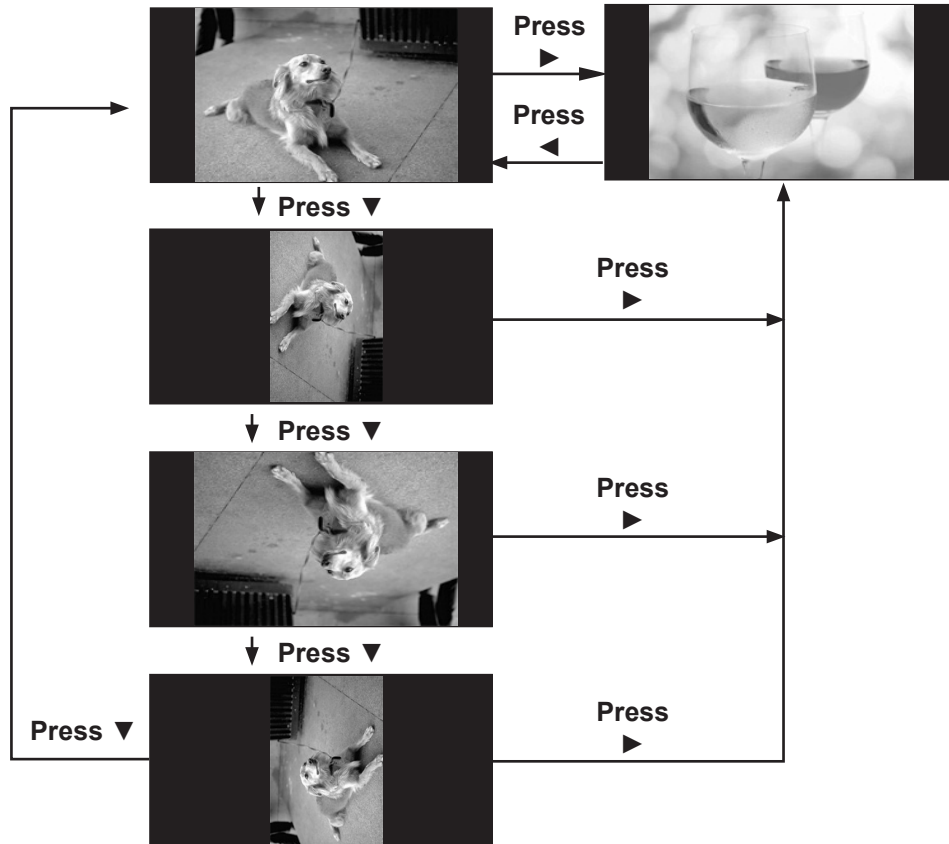

Continued in left column of next page.

Advanced Operation

Photo Viewer (SD Card/PC Card)

Continued from page 89.

Information Screen Display

Press OK: INFORMATION SCREEN is displayed.
(Rotation angle is maintained.)

Information Screen



Pressing EXIT returns to SINGLE VIEW SCREEN.

Note:

If a file name exceeds 8 characters, a file name different from the original is displayed.

Picture Adjustment

When OK is pressed while the Information Screen is displayed, the Picture Adjust menu (p. 50) is displayed. (Rotation angle is maintained.)

Picture Adjust menu



Pressing EXIT returns to SINGLE VIEW SCREEN.

- 2 Press EXIT with SINGLE VIEW screen displayed to return to the Index Area menu.

Slide Show Mode

- 1 Press **▲▼** to select "SLIDE," and press **OK**. Press **▲▼◀▶** to move cursor to desired file in Index Area. (Press **▲▼◀▶** to display next/previous page of 9 thumbnail files). Press **OK** to display SLIDE MENU. Press **▲▼** to select an item, and press **OK** repeatedly to set.

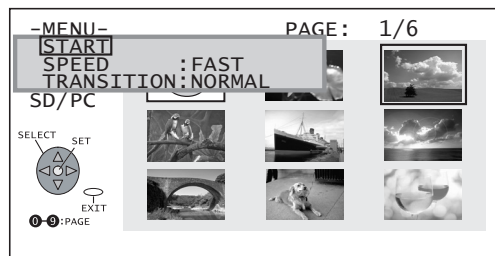

[START]
Starts slide show.

[SPEED]
FAST:
Image transition every 2 seconds.
MEDIUM:
Image transition every 5 seconds.
SLOW:
Image transition every 10 seconds.

Note:
The display intervals of 2, 5, and 10 seconds do not include file data reading time. The display interval becomes longer depending on the JPEG size.

[Transition]
NORMAL:
Image transition one by one.
WIPE:
Image transition from top to bottom.
BLIND:
Image transition in a series of band-like shapes that resemble window blinds.

- 2 **START SLIDE SHOW.**



Press OK to stop or resume slide show.

- 3 Press EXIT to exit this mode.

Replacing the lamp unit

The lamp unit is sold separately. To purchase a replacement, call the Panasonic accessory department, toll free at: 1-800-332-5368.

Lamp unit Part No. : TY-LA1000

Lamp unit replacement period

The Lamp is a consumable item and its life varies based on individual usage. Panasonic warrants the original Lamp for a period of 1 year from the date of purchase.

- The unit will detect when the Lamp's end of life is approaching and the following message will be displayed.
- The LAMP indicator light will be lit when the Lamp's end of life is approaching.

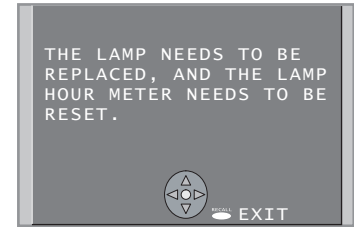

Influences of frequent lighting, continuous light use for over 24 hours, the number of times lit, the length of time between lightings, etc. may shorten lamp life.

(Because of this, we recommend having a replacement lamp on hand.)

WARNING

Failure to follow these warnings when replacing the lamp unit could result in personal injury:

- 1) The high-pressure lamp could explode if not properly handled and lamp fragments could cause injury.
- 2) Because the temperature of the lamp unit is elevated immediately after its use, touching it may cause burns. Please allow the lamp to cool before handling or replacing the lamp unit.
- 3) Handle the old lamp unit carefully. It can explode if not handled with care.
- 4) Wear gloves and safety eyeglasses when replacing the lamp unit.
- 5) If replacement of the lamp unit becomes necessary during the operation of the Device Display, follow the procedure below.
 - a. Press the POWER button on the Remote Control unit to turn off the power.
 - b. Wait for about 1 minute until the cooling fan stops.
 - **The lamp cooling fan will continue to operate for about 1 minute after turning off the power. Do not unplug the power cord from the outlet until the fan has stopped. Avoid interrupting the power line by using circuit breakers or switchable power strips.**
 - c. After the cooling fan has stopped, Unplug the power cord from the outlet.

- Please wait more than one hour for lamp replacement.
[If you need to replace the lamp more urgently]
- The Device Display has a forced cooling feature. After the POWER button is turned OFF, and sometime during about the first minute of the normal cooling fan operation, press the VOL+ button on the Device Display and the ▲ button on the Remote Control at same time for more than 5 seconds. The cooling fan operates for about 10 minutes.

Refer to the instructions enclosed with the lamp unit (Part No.: TY-LA1000) when replacing the lamp.

Remote Control Quick Reference Guide (Operating peripheral equipment)

Programming The Remote

The Universal Remote Control can be programmed to operate many manufacturers' components, using the component function buttons for VCR, DVD, DBS, RCVR or AUX. Follow the procedures for programming your Remote Control with or without a code for the component.

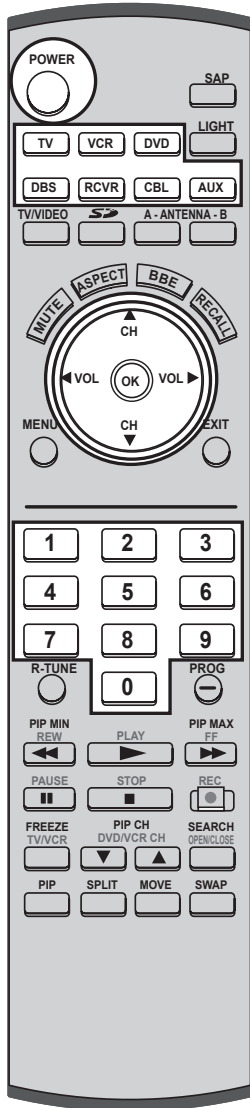

Setting up the remote using the numerical keys.

(When code is known):

1



Confirm that the external component is plugged and operating. Turn the component off.

Press OK and POWER together, for at least 5 seconds.

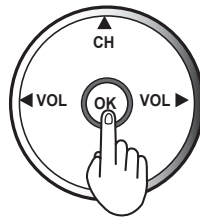

2



Press appropriate component button on the Remote Control VCR, DVD, DBS, RCVR, CBL or AUX (PVR or VCR2)

3

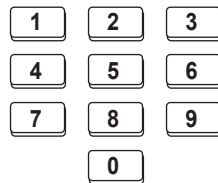

Enter the 3-digit component code using the Remote Control number keys (0 ~ 9 buttons). Press the Remote Control POWER to test the component. If the procedure was successful, the component will turn on.

Device	Operates	Default
TV	TV (Panasonic Only)	Panasonic Code
VCR	VCR (Preset)	Panasonic Code
DVD/CD	DVD and CD (Preset)	Panasonic Code
DBS	DBS STB & CBL STB (Preset)	Panasonic DBS Code
RCVR	Audio Receiver (Preset)	Panasonic RCVR Code
CBL	Cable (Preset)	Panasonic CABLE Code
AUX	Personal Video Recorders, Cassette and VCR2	Panasonic Personal Video Recorder Code

Notes:

- Determine the manufacturer of the component and look in the table for the code.
- If the component does not operate with the Remote Control, repeat the procedure using another code. (Some brands have multiple codes). If an incorrect code is entered, or if the procedure takes longer than 30 seconds, the programming will fail.

Remote Control Quick Reference Guide (Operating peripheral equipment)

Programming Without A Code

This procedure searches all codes and is called the “sequence method.”

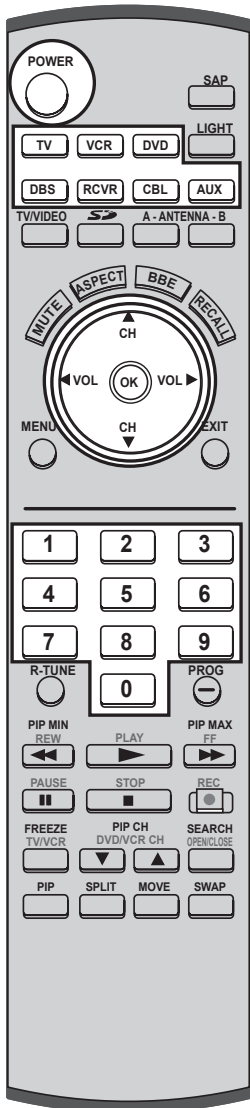

Setting to the remote using the step and set method
(When code is not known):

1



Confirm that the external component is plugged in and on. Turn the component off.

Press OK and POWER together, for at least 5 seconds.

+

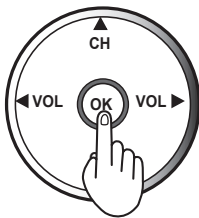

2



Press appropriate component button on the Remote Control.

3

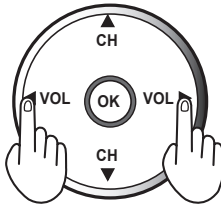

Press VOL ► to move forward to the next code. Press VOL ◀ to move backward.

Press the Remote Control POWER to test the component. If the procedure was successful, the component will turn on.

Note:

Repeat the above steps until the component code is found. It may take many attempts before the correct code is found.

4

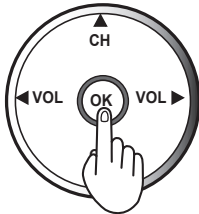

After the code is found, press OK to store the code.

Component Codes

The Universal Remote Control is capable of operating many component brands after entering a code. Some components may not operate because the codes are not available due to limited memory. The Universal Remote Control does not control all features found in each model.

Write the code numbers from tables in this space. This will serve as a reference if you need to program your Remote Control.

CABLE

Cable Box

VCR

Video Cassette Recorder

CD

Compact Disc Player

DBS

Digital Broadcast System

RCVR

Receiver or Amplifier

DVD

Digital Versatile Player

Other Component

Other Component

Other Component

Remote Control Quick Reference Guide (Operating peripheral equipment)

Infrared Codes Index

The Remote Control is capable of operating many brands of peripheral equipment. Refer to page 92 and 93 for programming procedures.

Notes:

- The Remote Control memory is limited and therefore some models may not operate. The Remote Control is not designed to control all features available in all models.
- After entering the proper infrared code, press the desired Mode Selection button on the Remote Control. Refer to page 10 to 11 and 97 to 98 for details on operating peripheral equipment using the Remote Control.

VCR Infrared Codes Index

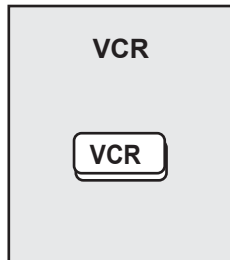

Codes For VCR		Codes For VCR (Contd.)	
Brand	Code	Brand	Code
Admiral	335	Optimus	306, 321, 328, 335
Aiwa	332	Orion	320, 326
Akai	314, 315, 316, 329	Panasonic	321, 322, 323, 324
Audio Dynamic	311, 339	Penney	300, 305, 310, 311, 324, 339, 345
Bell & Howell	305, 313	Pentax	300, 311, 345
Broksonic	320, 326	Philco	320, 323, 324, 326, 331, 343
Canon	323, 325	Philips	323, 324, 331
CCE	343	Pioneer	323
Citizen	306	Proscan	300, 301, 302, 323, 324, 331, 333, 345, 346
Craig	305, 306, 329	Quasar	321, 322, 323, 324
Curtis Mathes	324, 345	Radio Shack	305, 309, 324, 333, 336, 340
Daewoo	301, 324, 343	RCA	300, 301, 302, 323, 324, 331, 333, 345, 346
DBX	310, 311, 339	Realistic	305, 309, 324, 336, 340
Dimensia	345	Samsung	302, 304, 333
Emerson	303, 319, 320, 325, 326, 343	Sansui	320, 326, 339, 352
Fisher	305, 307, 308, 309, 313	Sanyo	305, 309, 313
Funai	320, 326, 334	Scott	301, 302, 304, 309, 320, 326, 338, 340, 347, 348
GE	324, 333, 345	Sears	300, 305, 306, 307, 308
Goldstar	306	Sharp	335, 336
Gradiente	334	Shintom	317
Hitachi	300, 323, 345	Signature 2000	335
Instant Replay	323, 324	Singer	337
Jensen	339	Sony	328, 329, 330
JVC	310, 311, 334, 339	Sylvania	323, 324, 331
Kenwood	306, 310, 311, 339	Tashiro	306
LXI	300, 305, 306, 307, 308, 309	Tatung	310, 311, 339
Magnavox	323, 324, 331	Teac	310, 311, 339
Marantz	310, 311, 339	Technics	321, 322, 323, 324
Marta	306	Teknika	324
Memorex	309, 324	Toshiba	301, 346
MGA	338, 340, 341, 347, 348	Vector Research	311
Minolta	300, 345	Wards	306, 309, 335, 336, 344
Mitsubishi	338, 340, 341, 347, 348	Yamaha	305, 310, 311, 339
Multitech	304, 347	Zenith	306, 344
NEC	310, 311, 334, 339		
Olympic	323, 324		

Remote Control Quick Reference Guide (Operating peripheral equipment)

CABLE CONVERTER BOX AND DVD, CD PLAYERS Infrared Codes Index

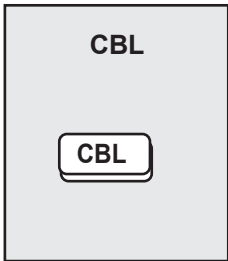

Codes For Cable Box	
Brand	Code
ABC	124
Archer	125, 132
Cableview	105, 132
Citizen	105, 122
Curtis	112, 113
Diamond	124, 125, 132
Eagle	129
Eastern	134
GCbrand	105, 132
Gemini	122
General Instrument/Jerrold	111, 119, 120, 121, 122, 124, 125, 126, 127
Hamlin	112, 118, 140, 141, 142, 145
Hitachi	103, 124
Macom	103, 104, 105
Magnavox	133
Memorex	130
Movietime	105, 132
Oak	102, 137, 139
Panasonic	109, 110, 114
Philips	106, 107, 128, 129, 130
Pioneer	101, 116
Pulsar	105, 132

Codes For Cable Box (Contd.)	
Brand	Code
Puser	132
RCA	115
Realistic	132
Regal	112, 118, 140, 141, 142, 145, 149
Regency	134
Rembrandt	105, 132, 137
Samsung	105
Scientific Atlanta	111, 112, 113
Slmark	101, 105
Sprucer	105, 110
Stargate	105, 110
Teleview	101, 105
Texscan	144
Tocom	135
Toshiba	104
Unika	125, 232
Universal	122, 132
Videoway	106
Viewstar	129, 130
Zenith	100, 117
Zenith/Drake Satellite	100



Codes For DVD	
Brand	Code
Denon	100
Ferguson	101
JVC	109
Mitsubishi	105
Nordmende	101
Panasonic	100
Philips	103
Pioneer	102
RCA	101

Codes For DVD (Contd.)	
Brand	Code
Saba	101
Samsung	110
Sharp	108
Sony	104
Technics	100
Thomson	101
Toshiba	103
Yamaha	100
Zenith	107

Codes For CD Player	
Brand	Code
Admiral	226
Aiwa	233, 235
Carver	229
Denon	242
Emerson	239
Fisher	205
Harman/ Kardon	219, 220, 221, 223
Hitachi	207
Jensen	234
JVC	240, 241, 245
Kardon	223
Kenwood	200, 201, 211, 245
LXI/Sears	236
Magnavox	229, 232
Marantz	229
McIntosh	221
Nakamichi	210
Onkyo	214, 215

Codes For CD Player (Contd.)	
Brand	Code
Optimus	208, 218, 220, 222
Panasonic	224, 225, 227
Philips	229, 230
Pioneer	208
Quasar	224, 225, 227
RCA	231, 237, 238, 247
Sansui	210, 246
Sanyo	205
Scott	210, 246
Sharp	242, 243
Sherwood	220
Sony	228
Soundesign	244
Teac	212, 216, 218
Technics	224, 225, 227
Victor	240, 241, 245
Yamaha	202, 203, 204

Remote Control Quick Reference Guide (Operating peripheral equipment)

CASSETTE PLAYERS, PERSONAL VIDEO RECORDERS, RECEIVERS, AMPLIFIERS, and DBS Infrared Codes Index

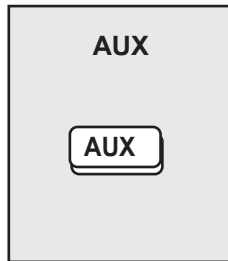

Codes For Cassette Decks	
Brand	Code
Aiwa	223, 224, 225
Denon	231
Fisher	203
Jensen	214
JVC	229, 230
Kenwood	200, 207
Marantz	202
Nakamichi	205
Onkyo	208, 209, 213
Panasonic	216, 218

Codes For Cassette Decks (Contd.)	
Brand	Code
Philips	222
Pioneer	204
RCA	226, 227, 228
Sansui	205, 210
Sharp	231
Sony	219, 220
Teac	210, 211, 215
Technics	216, 218
Yamaha	201, 202

Codes For Personal Video Recorders	
Brand	Code
Panasonic Replay TV	100
Philips Tivo	102
Sony Tivo	101

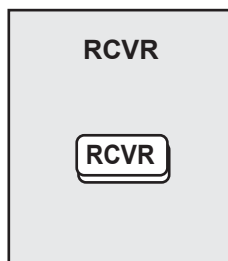

Codes For Receivers	
Brand	Code
Admiral	120
Aiwa	125, 126
Denon	134, 135, 136
Fisher	104
Garrard	113
Harman Kardon	115, 123
Jensen	129
JVC	132, 133
Kenwood	100, 108
Magnavox	127
Marantz	124
McIntosh	116
Nakamichi	106
Onkyo	109, 114

Codes For Receivers (Contd.)	
Brand	Code
Optimus	103, 127, 130, 131
Panasonic	118, 119, 121
Philips	123
Pioneer	105, 107
Quasar	118, 119, 121
RCA	103, 105, 127, 130, 131
Sansui	103, 111, 139
Sharp	134, 137
Sony	122
Soundesign	138
Teac	111, 112, 113
Technics	118, 119, 121
Victor	132, 133
Yamaha	101, 102

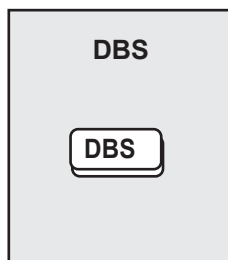

Codes For DBS	
Brand	Code
Dish Network (Echostar)	105, 115, 116
Echostar	105
Express VU	105, 115
G. E.	106
G.I. (General Instrument)	108
Gradiente	114
Hitachi	103, 111, 112
HNS (Hughes)	103

Codes For DBS (Contd.)	
Brand	Code
Magnavox	101, 102
Panasonic	104
Philips	101, 102
Primestar	108
Proscan	106, 109, 110, 113
RCA	106, 109, 110, 113
Sony	107
Star Choice	103, 108
Toshiba	100
Uniden	101, 102

Remote Control Quick Reference Guide (Operating peripheral equipment)











Operating Components with Remote Control

Note:

Refer to pages 10-11 for programming Remote Control procedure.







Operating a VCR

Program the Remote Control to use with VCR.

TO DO THIS...	PRESS
Turn on/off	
Select TV Input mode for VCR	
Change Channels up/down	
Record	
Play	
Stop	
Fast Forward	
Rewind the Tape	
Pause	
Change to TV or VCR Mode	
On screen VCR Display	

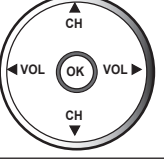
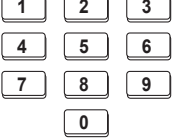

Operating a DBS

Program the Remote Control to use with DBS.

TO DO THIS...	PRESS
Turn on/off	
Display DBS menu	
Menu Navigation	
Select a Channel	
Program Information	
Back to previous channel	
Select next page up/down	
Exit menus	



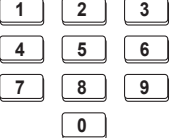
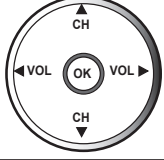



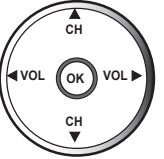

Operating a CABLE BOX

Program the Remote Control to use with Cable Box.

TO DO THIS...	PRESS
Turn on/off	
Select a Channel	
Change Channels Up/Down	
Back to previous channel	

Operating a DVD

Program the Remote Control to use with DVD.







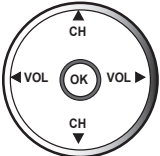

TO DO THIS...	PRESS
Turn on/off	
Next/Previous Chapter	
DVD Display	
Skip Search Reverse	
Skip Search Fast Forward	
Play	
DVD Open/Close	
Stop	
Still	
Slow +/-	

Remote Control Quick Reference Guide (Operating peripheral equipment)

Operating Components with Remote Control



Operating a Cassette Deck

To operate a cassette deck, the Remote Control must be in AUX mode and be programmed with the appropriate code for your equipment.

TO DO THIS...	PRESS
Turn on/off	
Receiver Volume Up/Down	
Deck A/B	
Record	
Play	
Stop	
Fast Forward	
Rewind the Tape	
Pause	

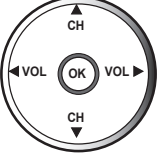
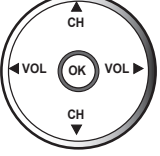

Operating a Receiver

Program the Remote Control to operate audio receiver.

TO DO THIS...	PRESS
Turn on/off	
Audio Mute	
RCVR. VOI Up Down	
Tuner Pre-set stations Up/Down	
To select AV Inputs or Components:	Press Remote Control number keys AV1: Press 1 AV2: Press 2 AV3: Press 3 AV4: Press 4 CD: Press 5 TUNER: Press 6 PHONO: Press 7 TAPE: Press 8 AUX: Press 9









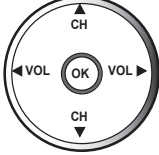
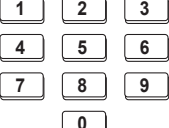

Operating a Receiver

Program the remote to operate audio receiver.

TO DO THIS...	PRESS
Surround VOL Down	
Surround VOL UP	
Center CH VOL Up/Down	

Operating a PVR (Personal Video Recorder)

Program the Remote Control to use with a PVR.

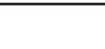
TO DO THIS...	PRESS
Turn on/off	
Display PVR menu	
PVR Navigation	
Select a Channel	
Play	
Record	
Pause	
Back to previous channel	
Exit menus	
Replay Zones	
Quick Skip	
Return to live	
PVR CH Up/Down	

Notes:

- Not all functions listed may be controllable.
- Some TV, Cable Box and DSS Receiver brands require you to turn on the power manually.

Troubleshooting

Before you call for service, determine the symptoms and make a few simple checks as shown below.

Symptoms		Checks	Page
Power does not turn ON.		<ul style="list-style-type: none"> Is the power plug plugged in? 	-
No picture even if the power is turned ON. LAMP indicator blinks red.		<ul style="list-style-type: none"> Please replace lamp with a new one. Please consult your nearest dealer, if not still repaired. 	12, 91
The power turns OFF.	The POWER indicator flashes orange twice every 5 seconds.	<ul style="list-style-type: none"> The lamp cover is ajar. Firmly replace the cover. 	-
	The TEMP indicator flashes 2 or 4 times every 5 seconds.	<ul style="list-style-type: none"> Check whether or not the vents are clogged. Is the set being used in a location that is hot? 	-
	The TEMP indicator flashes 5 times every 5 seconds.	<ul style="list-style-type: none"> Please consult your nearest dealer. 	-
	Power turns off while another indicator is flashing.	<ul style="list-style-type: none"> Please consult your nearest dealer. 	-
Remote Control does not function.		<ul style="list-style-type: none"> Are the batteries dead or inserted incorrectly? 	8
		<ul style="list-style-type: none"> Is the remote Control sensor in direct light of fluorescent lamps or other strong sources of light? 	-
		<ul style="list-style-type: none"> Did you correctly set the Remote Control code? 	92
Image shakes.		<ul style="list-style-type: none"> Is the antenna or antenna cable old, broken or shorted? 	-
Image is not clear.		<ul style="list-style-type: none"> Is the antenna cable connected properly? 	14-16
		<ul style="list-style-type: none"> Sudden changes in ambient temperature may cause condensation in the internal optics. Condensation should disappear after Power has been ON for a while. 	-
Color patches or no color.		<ul style="list-style-type: none"> When using a VCR and selecting channels on the TV, is the TV/VIDEO mode for the VCR set to TV? 	-
Image appears doubled or tripled.		<ul style="list-style-type: none"> Is the antenna facing the right direction? 	-
		<ul style="list-style-type: none"> Is the antenna receiving any signals reflected off of mountains or buildings. 	-
Images disappear at the top and bottom of the screen.		<ul style="list-style-type: none"> When using 16:9 image software, there is no picture at the top and bottom of the screen (cinema vision size software, etc.). 	-
During ZOOM modes, the image is cut off at the top and bottom.		<ul style="list-style-type: none"> Has the screen position been changed? If so, adjust screen positioning. 	40-41, 52-53
The Device Display set makes a high whistling sound when the power is ON.		<ul style="list-style-type: none"> This is the sound of the internal starting UP. This is not a malfunction. 	-
Some parts of the screen are always lit while others do not light up. Some parts of the screen do not light up.		<ul style="list-style-type: none"> This is a characteristic of the LCD panel and not a malfunction. 	-
Fan is operating even though TV Power is OFF.		<ul style="list-style-type: none"> This is because the cooling fan is operating. The fan will stop after about 1 minute. 	26
An OSD instructing to replace the lamp is displayed. (The LAMP indicator is lit red.)		<ul style="list-style-type: none"> Replace lamp with a new one. 	91
Relighting the lamp when it is hot makes a sound.		<ul style="list-style-type: none"> This is a characteristic of the lamp and not a malfunction. 	-
Leaving stationary images, such as still video images, web pages, or filler bars (used for NORMAL aspect mode), on-screen for an extended period of time can leave ghost images on the screen.		<ul style="list-style-type: none"> This is a characteristic of the LCD panel and not a malfunction. Try displaying constantly moving pictures which fill the entire screen, or turn the power OFF for a while to return the screen to normal. 	-
An OSD advising "AIR FILTER CLEANING..." is displayed.		<ul style="list-style-type: none"> Please consult your nearest dealer. 	-
When viewing with HDMI connection, picture is displayed with unnatural colors (as if red and blue are reversed).		<ul style="list-style-type: none"> Change UV Timing from NORMAL to INVERT. 	53

Specifications

	PT-43LCX64	PT-50LCX64	PT-60LCX64
Power Source	AC 120 V, 60 Hz		
Power Consumption	Power ON: Approx. 240 W (When audio is at maximum) Power OFF: Approx. 20 W (When cooling fan is stopped)		
LCD panels	0.7" Poly silicon TFT LCD panel x 3 921 600 (1 280 x 720) stripe pixels x 3 panels (16:9)		0.9" Poly silicon TFT LCD panel x 3 921 600 (1 280 x 720) stripe pixels x 3 panels (16:9)
Display	43-inch, 16 : 9 aspect ratio	50-inch, 16 : 9 aspect ratio	60-inch, 16 : 9 aspect ratio
Speaker	2 Speakers 30 W [15 W + 15 W] (10 % THD)		
HID Lamp	100 W HID (High Intensity Discharge) Lamp		
Channel Capability (ATSC/NYSC)	VHF/UHF Cable	2-69 1-135	
Input Terminals	RGB INPUT 1-2	RGB analog AUDIO	0.7 Vp-p (75 Ω) (D-SUB15P) 0.5 Vrms (M3 Stereo mini Pin Jack)
	AV INPUT 1-3	VIDEO S-VIDEO AUDIO L-R	1.0 Vp-p (75 Ω) (RCA Pin Jack) Y : 1 Vp-p (75 Ω), C : 0.286 Vp-p (75 Ω) (Mini DIN 4 pin) 0.5 Vrms (RCA Pin Jack x 2)
	COMPONENT VIDEO INPUT 1-3	Y PB / PR AUDIO L-R	1.0 Vp-p (with sync) (75 Ω) (Pin Jack) ± 0.35 Vp-p (75 Ω) (Pin Jack x 2) 0.5 Vrms (RCA Pin Jack x 2)
	HDMI	HDMI type A Connector AUDIO L-R	0.5 Vrms (RCA Pin Jack Type x 2)
Card slot	SD Card slot	SD Card, Multi Media Card	
	PC Card slot	Compact Flash, Smart Media, Memory Stick, xD Picture Card	
Output signals (AV OUT)	VIDEO S-VIDEO AUDIO L-R	1.0 Vp-p (75 Ω) (RCA Pin Jack) Y : 1 Vp-p (75 Ω), C : 0.286 Vp-p (75 Ω) (Mini DIN 4 pin) 0.5 Vrms (RCA Pin Jack x 2)	
Tuner	ATSC digital tuner with digital cable module		
Dimensions (W x H x D)	1 259 mm (W) x 795 mm (H) x 324 mm (D) 49-9/16" (W) x 31-5/16" (H) x 12-6/8" (D)	1 416 mm (W) x 897 mm (H) x 389 mm (D) 55-12/16" (W) x 35-5/16" (H) x 15-5/16" (D)	1 637 mm (W) x 1 050 mm (H) x 459 mm (D) 64 7/16" (W) x 41 6/16" (H) x 18 1/16" (D)
Weight (Mass)	32.1 kg (70.8 lbs.) Net	38.4 kg (84.7 lbs.) Net	46.8 kg (103.2 lbs.) Net
Operating conditions	Temperature : 0 °C – 35 °C (32 °F - 95 °F) Humidity : 20 % - 80 % (non-condensing)		

Note:

Design and Specifications are subject to change without notice. Weight and Dimensions shown are approximate.

Warning Indicators

This unit has indicators (lights on the front) to let you know the unit's internal condition. (See page 12) Depending on the condition, the Lamp, Power, or Temp indicator will flash to alert you. In this case, turn unit off and follow the measures below.



	Indicator	Symptom	Problem	Possible Solution
Temp Indicator	Flashes red 1 or 3 times every 5 seconds.	Power shuts off.	Malfunction	Contact a service center.
	Flashes red 2 or 4 times every 5 seconds.	Power shuts off.	Internal overheat error.	Wait a while, then turn unit back on.
	Flashes red 5 times every 5 seconds.	Power shuts off.	Malfunction	Contact a service center.
Lamp Indicator	Lights solid red.	OSD appears every time power is turned on.	Maximum Lamp life hours exceeded.	Replace Lamp
	Flashes red 1 time every 5 seconds.	Power shuts off.	Lamp will not light or light is abnormal.	Try turning Power On several times. If error persists, contact service center.
	Flashes red 2 times every 5 seconds.	Power shuts off.	Lamp voltage is abnormal.	Contact service center.
	Flashes red 3 times every 5 seconds.	Power shuts off.	Lamp temperature is too high.	Contact service center.
	Flashes red 4 times every 5 seconds.	Power shuts off.	Other error.	Contact service center.
Power Indicator	Flashes orange 1 time every 5 seconds.	Power shuts off.	The internal cooling fan is not working.	Contact service center.
	Flashes orange 2 times every 5 seconds.	Power shuts off.	The Lamp Cover is unsecured.	Securely attach Lamp Cover.

Note:

- If unit power is turned back on after performing the appropriate measures, make sure the unit has sufficiently cooled down. If the unit was used for a long period such that the lamp needs enough time to cool down, this may take a while.

Cleaning

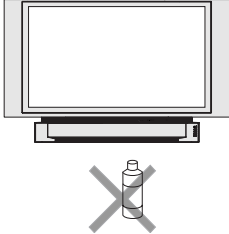
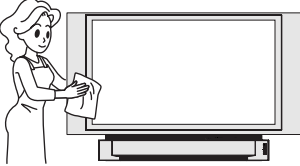
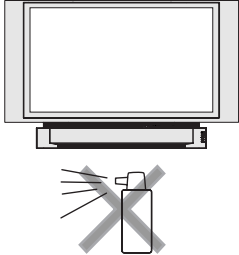
To ensure continued excellent performance by this product, periodic cleaning is recommended.

	<p>The unit contains many plastic parts. For this reason DO NOT use benzine, thinner or other chemicals to clean the unit.</p>		<p>Dust will accumulate on the picture screen. Please wipe with a soft cloth from time to time. If you use a chemically treated cloth, please be careful to follow the instructions that come with the cloth.</p>
	<p>DO NOT bring into contact with insecticide or other volatile substances. DO NOT allow the unit to come into contact for extended periods with rubber or vinyl products.</p>		<p>Remove dirt and soiling by wiping with a light cloth. Even if the unit is heavily soiled, do not apply cleaner directly to the unit. Soak a cloth in a solution of neutral cleanser diluted with water. Then wring out the cloth, wipe the unit clean, and finish by wiping with a dry cloth. Do not use any type of cleansers on the picture screen.</p>

Customer Services Directory

Obtain Product Information and Operating Assistance; locate your nearest Dealer or Servicer; purchase Parts and Accessories; or make Customer Service and Literature requests by visiting our Web Site at:

<http://www.panasonic.com/support>

or, contact us via the web at:

<http://www.panasonic.com/contactinfo>

You may also contact us directly at:

1-800-211-PANA (7262),

Monday-Friday 9 am-9 pm; Saturday-Sunday 10 am-7 pm, EST.

For hearing or speech impaired TTY users, TTY : 1-877-833-8855

Accessory Purchases

Purchase Parts, Accessories and Instruction Books online for all Panasonic Products by visiting our Web Site at:

<http://www.pasc.panasonic.com>

or, send your request by E-mail to:

npcparts@panasonic.com

You may also contact us directly at:

1-800-332-5368 (Phone) 1-800-237-9080 (Fax Only) (Monday – Friday 9 am to 8 pm, EST.)

Panasonic Services Company

20421 84th Avenue South,

Kent, WA 98032

(We Accept Visa, MasterCard, Discover Card, American Express, and Personal Checks)

For hearing or speech impaired TTY users, TTY : 1-866-605-1277

Service in Puerto Rico

Matsushita Electric of Puerto Rico, Inc. Panasonic Sales Company

Factory Servicer:

Ave. 65 de Infantería, Km. 9.5, San Gabriel Industrial Park, Carolina, Puerto Rico 00985

Phone (787)750-4300 Fax (787)768-2910

As of October 2003

Limited Warranty

PANASONIC CONSUMER
ELECTRONICS COMPANY, DIVISION
OF MATSUSHITA ELECTRIC
CORPORATION OF AMERICA
One Panasonic Way
Secaucus, New Jersey 07094

PANASONIC SALES COMPANY,
DIVISION OF MATSUSHITA
ELECTRIC OF PUERTO RICO, INC.,
Ave. 65 de Infantería, Km. 9.5
San Gabriel Industrial Park, Carolina,
Puerto Rico 00985

Panasonic Multimedia Device Display Limited Warranty

Limited Warranty Coverage

If your product does not work properly because of a defect in materials or workmanship, Panasonic Consumer Electronics Company or Panasonic Sales Company (collectively referred to as “the warrantor”) will, for the length of the period indicated on the chart below, which starts with the date of original purchase (“warranty period”), at its option either (a) repair your product with new or refurbished parts, or (b) replace it with a new or a refurbished product. The decision to repair or replace will be made by the warrantor.

CATEGORY	PARTS	LABOR	SERVICE
Digital Device Display	One (1) Year	One (1) Year	In-Home or Carry-In

During the “Labor” warranty period there will be no charge for labor. During the “Parts” warranty period, there will be no charge for parts. You must carry-in your product or arrange for in-home service during the warranty period. If non-rechargeable batteries are included, they are not warranted. This warranty only applies to products purchased and serviced in the United States or Puerto Rico. This warranty is extended only to the original purchaser of a new product which was not sold “as is”. A purchase receipt or other proof of the original purchase date is required for warranty service.

Carry-in or In-Home Service

For In-Home or Carry-In Service in the United States call 1-888-VIEW-PTV (1-888-843-9788).

For assistance in Puerto Rico call Panasonic Sales Company (787)-750-4300 or fax (787)-768-2910.

In-Home service requires clear, complete and easy access to the product by the authorized servicer and does not include removal or re-installation of an installed product. It is possible that certain in-home repairs will not be completed in-home, but will require that the product, or parts of the product, be removed for shop diagnosis and/or repair and then returned.

Limited Warranty Limits And Exclusions

This warranty ONLY COVERS failures due to defects in materials or workmanship, and DOES NOT COVER normal wear and tear or cosmetic damage. The warranty also does not cover damages which occurred in shipment, or failures which are caused by products not supplied by the warrantor, or failures which result from accidents, misuse, abuse, neglect, mishandling, misapplication, alteration, faulty installation, set-up adjustments, misadjustment of consumer controls, power line surge, lightning damage, modification, or commercial use (such as in a hotel, office, restaurant, or other business), rental use of the product, service by anyone other than a Factory Servicenter or other Authorized Servicer, or damage that is attributable to acts of God.

THERE ARE NO EXPRESS WARRANTIES EXCEPT AS LISTED UNDER ‘ LIMITED WARRANTY COVERAGE’. THE WARRANTOR IS NOT LIABLE FOR INCIDENTAL OR CONSEQUENTIAL DAMAGES RESULTING FROM THE USE OF THIS PRODUCT, OR ARISING OUT OF ANY BREACH OF THIS WARRANTY. (As examples, this excludes damages for lost time, cost of having someone remove or re-install an installed unit if applicable, or travel to and from the servicer. The items listed are not exclusive, but are for illustration only.) **ALL EXPRESS AND IMPLIED WARRANTIES, INCLUDING THE WARRANTY OF MERCHANTABILITY, ARE LIMITED TO THE PERIOD OF THE LIMITED WARRANTY.**

Some states do not allow the exclusion or limitation of incidental or consequential damages, or limitations on how long an implied warranty lasts, so the exclusions may not apply to you.

This warranty gives you specific legal rights and you may also have other rights, which vary, from state to state. If a problem with this product develops during or after the warranty period, you may contact your dealer or Servicenter. If the problem is not handled to your satisfaction, then write to the warrantor's Consumer Affairs Department at the addresses listed for the warrantor.

PARTS AND SERVICE (INCLUDING COST OF AN IN-HOME SERVICE CALL, WHERE APPLICABLE) WHICH ARE NOT COVERED BY THIS LIMITED WARRANTY ARE YOUR RESPONSIBILITY.

This product utilizes the following so called “open source” software:

- (1) the software which is licensed under the GNU GENERAL PUBLIC LICENSE,
- (2) the software which is licensed under the GNU LESSER GENERAL PUBLIC LICENSE, and
- (3) software developed by the thrd parties and available under certain terms and conditions.

For the software categorized as (1) and (2), please refer to the terms and conditions of the following GNU GENERAL PUBLIC LICENSE and GNU LESSER GENERAL PUBLIC LICENSE respectively.

If you wish to get further information as to the software, please contact the web site below.

<http://www.fsf.org/licenses/> and <http://www.am-linux.jp/>

GNU GENERAL PUBLIC LICENSE

Version 2, June 1991

Copyright (C) 1989, 1991 Free Software Foundation, Inc.
59 Temple Place, Suite 330, Boston, MA 02111-1307 USA

Everyone is permitted to copy and distribute verbatim copies of this license document, but changing it is not allowed.

Preamble

The licenses for most software are designed to take away your freedom to share and change it. By contrast, the GNU General Public License is intended to guarantee your freedom to share and change free software--to make sure the software is free for all its users. This General Public License applies to most of the Free Software Foundation's software and to any other program whose authors commit to using it. (Some other Free Software Foundation software is covered by the GNU Library General Public License instead.) You can apply it to your programs, too.

When we speak of free software, we are referring to freedom, not price. Our General Public Licenses are designed to make sure that you have the freedom to distribute copies of free software (and charge for this service if you wish), that you receive source code or can get it if you want it, that you can change the software or use pieces of it in new free programs; and that you know you can do these things.

To protect your rights, we need to make restrictions that forbid anyone to deny you these rights or to ask you to surrender the rights. These restrictions translate to certain responsibilities for you if you distribute copies of the software, or if you modify it.

For example, if you distribute copies of such a program, whether gratis or for a fee, you must give the recipients all the rights that you have. You must make sure that they, too, receive or can get the source code. And you must show them these terms so they know their rights.

We protect your rights with two steps: (1) copyright the software, and (2) offer you this license which gives you legal permission to copy, distribute and/or modify the software.

Also, for each author's protection and ours, we want to make certain that everyone understands that there is no warranty for this free software. If the software is modified by someone else and passed on, we want its recipients to know that what they have is not the original, so that any problems introduced by others will not reflect on the original authors' reputations.

Finally, any free program is threatened constantly by software patents. We wish to avoid the danger that redistributors of a free program will individually obtain patent licenses, in effect making the program proprietary. To prevent this, we have made it clear that any patent must be licensed for everyone's free use or not licensed at all.

The precise terms and conditions for copying, distribution and modification follow.

TERMS AND CONDITIONS FOR COPYING, DISTRIBUTION AND MODIFICATION

0. This License applies to any program or other work which contains a notice placed by the copyright holder saying it may be distributed under the terms of this General Public License. The “Program”, below, refers to any such program or work, and a “work based on the Program” means either the Program or any derivative work under copyright law: that is to say, a work containing the Program or a portion of it, either verbatim or with modifications and/or translated into another language. (Hereinafter, translation is included without limitation in the term “modification”.) Each licensee is addressed as “you”.

Activities other than copying, distribution and modification are not covered by this License; they are outside its scope. The act of running the Program is not restricted, and the output from the Program is covered only if its contents constitute a work based on the Program (independent of having been made by running the Program). Whether that is true depends on what the Program does.

1. You may copy and distribute verbatim copies of the Program's source code as you receive it, in any medium, provided that you conspicuously and appropriately publish on each copy an appropriate copyright notice and disclaimer of warranty; keep intact all the notices that refer to this License and to the absence of any warranty; and give any other recipients of the Program a copy of this License along with the Program.

You may charge a fee for the physical act of transferring a copy, and you may at your option offer warranty protection in exchange for a fee.

2. You may modify your copy or copies of the Program or any portion of it, thus forming a work based on the Program, and copy and distribute such modifications or work under the terms of Section 1 above, provided that you also meet all of these conditions:

- a) You must cause the modified files to carry prominent notices stating that you changed the files and the date of any change.
- b) You must cause any work that you distribute or publish, that in whole or in part contains or is derived from the Program or any part thereof, to be licensed as a whole at no charge to all third parties under the terms of this License.
- c) If the modified program normally reads commands interactively when run, you must cause it, when started running for such interactive use in the most ordinary way, to print or display an announcement including an appropriate copyright notice and a notice that there is no warranty (or else, saying that you provide a warranty) and that users may redistribute the program under these conditions, and telling the user how to view a copy of this License. (Exception: if the Program itself is interactive but does not normally print such an announcement, your work based on the Program is not required to print an announcement.)

These requirements apply to the modified work as a whole. If identifiable sections of that work are not derived from the Program, and can be reasonably considered independent and separate works in themselves, then this License, and its terms, do not apply to those sections when you distribute them as separate works. But when you distribute the same sections as part of a whole which is a work based on the Program, the distribution of the whole must be on the terms of this License, whose permissions for other licensees extend to the entire whole, and thus to each and every part regardless of who wrote it.

Thus, it is not the intent of this section to claim rights or contest your rights to work written entirely by you; rather, the intent is to exercise the right to control the distribution of derivative or collective works based on the Program.

In addition, mere aggregation of another work not based on the Program with the Program (or with a work based on the Program) on a volume of a storage or distribution medium does not bring the other work under the scope of this License.

3. You may copy and distribute the Program (or a work based on it, under Section 2) in object code or executable form under the terms of Sections 1 and 2 above provided that you also do one of the following:

- a) Accompany it with the complete corresponding machine-readable source code, which must be distributed under the terms of Sections 1 and 2 above on a medium customarily used for software interchange; or,
- b) Accompany it with a written offer, valid for at least three years, to give any third party, for a charge no more than your cost of physically performing source distribution, a complete machine-readable copy of the corresponding source code, to be distributed under the terms of Sections 1 and 2 above on a medium customarily used for software interchange; or,
- c) Accompany it with the information you received as to the offer to distribute corresponding source code. (This alternative is allowed only for noncommercial distribution and only if you received the program in object code or executable form with such an offer, in accord with Subsection b above.)

The source code for a work means the preferred form of the work for making modifications to it. For an executable work, complete source code means all the source code for all modules it contains, plus any associated interface definition files, plus the scripts used to control compilation and installation of the executable. However, as a special exception, the source code distributed need not include anything that is normally distributed (in either source or binary form) with the major components (compiler, kernel, and so on) of the operating system on which the executable runs, unless that component itself accompanies the executable.

If distribution of executable or object code is made by offering access to copy from a designated place, then offering equivalent access to copy the source code from the same place counts as distribution of the source code, even though third parties are not compelled to copy the source along with the object code.

4. You may not copy, modify, sublicense, or distribute the Program except as expressly provided under this License. Any attempt otherwise to copy, modify, sublicense or distribute the Program is void, and will automatically terminate your rights under this License. However, parties who have received copies, or rights, from you under this License will not have their licenses terminated so long as such parties remain in full compliance.

5. You are not required to accept this License, since you have not signed it. However, nothing else grants you permission to modify or distribute the Program or its derivative works. These actions are prohibited by law if you do not accept this License. Therefore, by modifying or distributing the Program (or any work based on the Program), you indicate your acceptance of this License to do so, and all its terms and conditions for copying, distributing or modifying the Program or works based on it.

6. Each time you redistribute the Program (or any work based on the Program), the recipient automatically receives a license from the original licensor to copy, distribute or modify the Program subject to these terms and conditions. You may not impose any further restrictions on the recipients' exercise of the rights granted herein. You are not responsible for enforcing compliance by third parties to this License.

7. If, as a consequence of a court judgment or allegation of patent infringement or for any other reason (not limited to patent issues), conditions are imposed on you (whether by court order, agreement or otherwise) that contradict the conditions of this License, they do not excuse you from the conditions of this License. If you cannot distribute so as to satisfy simultaneously your obligations under this License and any other pertinent obligations, then as a consequence you may not distribute the Program at all. For example, if a patent license would not permit royalty-free redistribution of the Program by all those who receive copies directly or indirectly through you, then the only way you could satisfy both it and this License would be to refrain entirely from distribution of the Program.

If any portion of this section is held invalid or unenforceable under any particular circumstance, the balance of the section is intended to apply and the section as a whole is intended to apply in other circumstances.

It is not the purpose of this section to induce you to infringe any patents or other property right claims or to contest validity of any such claims; this section has the sole purpose of protecting the integrity of the free software distribution system, which is implemented by public license practices. Many people have made generous contributions to the wide range of software distributed through that system in reliance on consistent application of that system; it is up to the author/donor to decide if he or she is willing to distribute software through any other system and a licensee cannot impose that choice.

This section is intended to make thoroughly clear what is believed to be a consequence of the rest of this License.

8. If the distribution and/or use of the Program is restricted in certain countries either by patents or by copyrighted interfaces, the original copyright holder who places the Program under this License may add an explicit geographical distribution limitation excluding those countries, so that distribution is permitted only in or among countries not thus excluded. In such case, this License incorporates the limitation as if written in the body of this License.

9. The Free Software Foundation may publish revised and/or new versions of the General Public License from time to time. Such new versions will be similar in spirit to the present version, but may differ in detail to address new problems or concerns.

Each version is given a distinguishing version number. If the Program specifies a version number of this License which applies to it and "any later version", you have the option of following the terms and conditions either of that version or of any later version published by the Free Software Foundation. If the Program does not specify a version number of this License, you may choose any version ever published by the Free Software Foundation.

10. If you wish to incorporate parts of the Program into other free programs whose distribution conditions are different, write to the author to ask for permission. For software which is copyrighted by the Free Software Foundation, write to the Free Software Foundation; we sometimes make exceptions for this. Our decision will be guided by the two goals of preserving the free status of all derivatives of our free software and of promoting the sharing and reuse of software generally.

NO WARRANTY

11. BECAUSE THE PROGRAM IS LICENSED FREE OF CHARGE, THERE IS NO WARRANTY FOR THE PROGRAM, TO THE EXTENT PERMITTED BY APPLICABLE LAW. EXCEPT WHEN OTHERWISE STATED IN WRITING THE COPYRIGHT HOLDERS AND/OR OTHER PARTIES PROVIDE THE PROGRAM "AS IS" WITHOUT WARRANTY OF ANY KIND, EITHER EXPRESSED OR IMPLIED, INCLUDING, BUT NOT LIMITED TO, THE IMPLIED WARRANTIES OF MERCHANTABILITY AND FITNESS FOR A PARTICULAR PURPOSE. THE ENTIRE RISK AS TO THE QUALITY AND PERFORMANCE OF THE PROGRAM IS WITH YOU. SHOULD THE PROGRAM PROVE DEFECTIVE, YOU ASSUME THE COST OF ALL NECESSARY SERVICING, REPAIR OR CORRECTION.

12. IN NO EVENT UNLESS REQUIRED BY APPLICABLE LAW OR AGREED TO IN WRITING WILL ANY COPYRIGHT HOLDER, OR ANY OTHER PARTY WHO MAY MODIFY AND/OR REDISTRIBUTE THE PROGRAM AS PERMITTED ABOVE, BE LIABLE TO YOU FOR DAMAGES, INCLUDING ANY GENERAL, SPECIAL, INCIDENTAL OR CONSEQUENTIAL DAMAGES ARISING OUT OF THE USE OR INABILITY TO USE THE PROGRAM (INCLUDING BUT NOT LIMITED TO LOSS OF DATA OR DATA BEING RENDERED INACCURATE OR LOSSES SUSTAINED BY YOU OR THIRD PARTIES OR A FAILURE OF THE PROGRAM TO OPERATE WITH ANY OTHER PROGRAMS), EVEN IF SUCH HOLDER OR OTHER PARTY HAS BEEN ADVISED OF THE POSSIBILITY OF SUCH DAMAGES.

END OF TERMS AND CONDITIONS

How to Apply These Terms to Your New Programs

If you develop a new program, and you want it to be of the greatest possible use to the public, the best way to achieve this is to make it free software which everyone can redistribute and change under these terms.

To do so, attach the following notices to the program. It is safest to attach them to the start of each source file to most effectively convey the exclusion of warranty; and each file should have at least the "copyright" line and a pointer to where the full notice is found.

<one line to give the program's name and an idea of what it does.>
Copyright (C) <year> <name of author>

This program is free software; you can redistribute it and/or modify it under the terms of the GNU General Public License as published by the Free Software Foundation; either version 2 of the License, or (at your option) any later version.

This program is distributed in the hope that it will be useful, but WITHOUT ANY WARRANTY; without even the implied warranty of MERCHANTABILITY or FITNESS FOR A PARTICULAR PURPOSE. See the GNU General Public License for more details.

You should have received a copy of the GNU General Public License along with this program; if not, write to the Free Software Foundation, Inc., 59 Temple Place - Suite 330, Boston, MA 02111-1307, USA

Also add information on how to contact you by electronic and paper mail. If the program is interactive, make it output a short notice like this when it starts in an interactive mode:

Gnomovision version 69, Copyright (C) year name of author
Gnomovision comes with ABSOLUTELY NO WARRANTY; for details type show w'.
This is free software, and you are welcome to redistribute it under certain conditions; type 'show c' for details.

The hypothetical commands 'show w' and 'show c' should show the appropriate parts of the General Public License. Of course, the commands you use may be called something other than 'show w' and 'show c'; they could even be mouse-clicks or menu items--whatever suits your program.

You should also get your employer (if you work as a programmer) or your school, if any, to sign a "copyright disclaimer" for the program, if necessary. Here is a sample; alter the names:

Yoyodyne, Inc., hereby disclaims all copyright interest in the program 'Gnomovision' (which makes passes at compilers) written by James Hacker.

<signature of Ty Coon>, 1 April 1989
Ty Coon, President of Vice

This General Public License does not permit incorporating your program into proprietary programs. If your program is a subroutine library, you may consider it more useful to permit linking proprietary applications with the library. If this is what you want to do, use the GNU Library General Public License instead of this License.

GNU LESSER GENERAL PUBLIC LICENSE

Version 2.1, February 1999

Copyright (C) 1991, 1999 Free Software Foundation, Inc.
59 Temple Place, Suite 330, Boston, MA 02111-1307 USA
Everyone is permitted to copy and distribute verbatim copies of this license document, but changing it is not allowed.

[This is the first released version of the Lesser GPL. It also counts as the successor of the GNU Library Public License, version 2, hence the version number 2.1.]

Preamble

The licenses for most software are designed to take away your freedom to share and change it. By contrast, the GNU General Public Licenses are intended to guarantee your freedom to share and change free software--to make sure the software is free for all its users.

This license, the Lesser General Public License, applies to some specially designated software packages--typically libraries--of the Free Software Foundation and other authors who decide to use it. You can use it too, but we suggest you first think carefully about whether this license or the ordinary General Public License is the better strategy to use in any particular case, based on the explanations below.

When we speak of free software, we are referring to freedom of use, not price. Our General Public Licenses are designed to make sure that you have the freedom to distribute copies of free software (and charge for this service if you wish); that you receive source code or can get it if you want it; that you can change the software and use pieces of it in new free programs; and that you are informed that you can do these things.

To protect your rights, we need to make restrictions that forbid distributors to deny you these rights or to ask you to surrender these rights. These restrictions translate to certain responsibilities for you if you distribute copies of the library or if you modify it.

For example, if you distribute copies of the library, whether gratis or for a fee, you must give the recipients all the rights that we gave you. You must make sure that they, too, receive or can get the source code. If you link other code with the library, you must provide complete object files to the recipients, so that they can relink them with the library after making changes to the library and recompiling it. And you must show them these terms so they know their rights.

We protect your rights with a two-step method: (1) we copyright then library, and (2) we offer you this license, which gives you legal permission to copy, distribute and/or modify the library.

To protect each distributor, we want to make it very clear that there is no warranty for the free library. Also, if the library is modified by someone else and passed on, the recipients should know that what they have is not the original version, so that the original author's reputation will not be affected by problems that might be introduced by others.

Finally, software patents pose a constant threat to the existence of any free program. We wish to make sure that a company cannot effectively restrict the users of a free program by obtaining a restrictive license from a patent holder. Therefore, we insist that any patent license obtained for a version of the library must be consistent with the full freedom of use specified in this license.

Most GNU software, including some libraries, is covered by the ordinary GNU General Public License. This license, the GNU Lesser General Public License, applies to certain designated libraries, and is quite different from the ordinary General Public License. We use this

license for certain libraries in order to permit linking those libraries into non-free programs.

When a program is linked with a library, whether statically or using a shared library, the combination of the two is legally speaking a combined work, a derivative of the original library. The ordinary General Public License therefore permits such linking only if the entire combination fits its criteria of freedom. The Lesser General Public License permits more lax criteria for linking other code with the library.

We call this license the "Lesser" General Public License because it does Less to protect the user's freedom than the ordinary General Public License. It also provides other free software developers Less of an advantage over competing non-free programs. These disadvantages are the reason we use the ordinary General Public License for many libraries. However, the Lesser license provides advantages in certain special circumstances.

For example, on rare occasions, there may be a special need to encourage the widest possible use of a certain library, so that it becomes a de-facto standard. To achieve this, non-free programs must be allowed to use the library. A more frequent case is that a free library does the same job as widely used non-free libraries. In this case, there is little to gain by limiting the free library to free software only, so we use the Lesser General Public License.

In other cases, permission to use a particular library in non-free programs enables a greater number of people to use a large body of free software. For example, permission to use the GNU C Library in non-free programs enables many more people to use the whole GNU operating system, as well as its variant, the GNU/Linux operating system.

Although the Lesser General Public License is Less protective of the users' freedom, it does ensure that the user of a program that is linked with the Library has the freedom and the wherewithal to run that program using a modified version of the Library.

The precise terms and conditions for copying, distribution and modification follow. Pay close attention to the difference between a "work based on the library" and a "work that uses the library". The former contains code derived from the library, whereas the latter must be combined with the library in order to run.

TERMS AND CONDITIONS FOR COPYING, DISTRIBUTION AND MODIFICATION

0. This License Agreement applies to any software library or other program which contains a notice placed by the copyright holder or other authorized party saying it may be distributed under the terms of this Lesser General Public License (also called "this License"). Each licensee is addressed as "you".

A "library" means a collection of software functions and/or data prepared so as to be conveniently linked with application programs (which use some of those functions and data) to form executables.

The "Library", below, refers to any such software library or work which has been distributed under these terms. A "work based on the Library" means either the Library or any derivative work under copyright law: that is to say, a work containing the Library or a portion of it, either verbatim or with modifications and/or translated straightforwardly into another language. (Hereinafter, translation is included without limitation in the term "modification".)

"Source code" for a work means the preferred form of the work for making modifications to it. For a library, complete source code means all the source code for all modules it contains, plus any associated interface definition files, plus the scripts used to control compilation and installation of the library.

Activities other than copying, distribution and modification are not covered by this License; they are outside its scope. The act of running a program using the Library is not restricted, and output from such a program is covered only if its contents constitute a work based on the Library (independent of the use of the Library in a tool for writing it). Whether that is true depends on what the Library does and what the program that uses the Library does.

1. You may copy and distribute verbatim copies of the Library's complete source code as you receive it, in any medium, provided that you conspicuously and appropriately publish on each copy an appropriate copyright notice and disclaimer of warranty; keep intact all the notices that refer to this License and to the absence of any warranty; and distribute a copy of this License along with the Library.

You may charge a fee for the physical act of transferring a copy, and you may at your option offer warranty protection in exchange for a fee.

2. You may modify your copy or copies of the Library or any portion of it, thus forming a work based on the Library, and copy and distribute such modifications or work under the terms of Section 1 above, provided that you also meet all of these conditions:

- a) The modified work must itself be a software library.
- b) You must cause the files modified to carry prominent notices stating that you changed the files and the date of any change.
- c) You must cause the whole of the work to be licensed at no charge to all third parties under the terms of this License.
- d) If a facility in the modified Library refers to a function or a table of data to be supplied by an application program that uses the facility, other than as an argument passed when the facility is invoked, then you must make a good faith effort to ensure that, in the event an application does not supply such function or table, the facility still operates, and performs whatever part of its purpose remains meaningful.

(For example, a function in a library to compute square roots has a purpose that is entirely well-defined independent of the application. Therefore, Subsection 2d requires that any application-supplied

function or table used by this function must be optional: if the application does not supply it, the square root function must still compute square roots.)

These requirements apply to the modified work as a whole. If identifiable sections of that work are not derived from the Library, and can be reasonably considered independent and separate works in themselves, then this License, and its terms, do not apply to those sections when you distribute them as separate works. But when you distribute the same sections as part of a whole which is a work based on the Library, the distribution of the whole must be on the terms of this License, whose permissions for other licensees extend to the entire whole, and thus to each and every part regardless of who wrote it.

Thus, it is not the intent of this section to claim rights or contest your rights to work written entirely by you; rather, the intent is to exercise the right to control the distribution of derivative or collective works based on the Library.

In addition, mere aggregation of another work not based on the Library with the Library (or with a work based on the Library) on a volume of a storage or distribution medium does not bring the other work under the scope of this License.

3. You may opt to apply the terms of the ordinary GNU General Public License instead of this License to a given copy of the Library. To do this, you must alter all the notices that refer to this License, so that they refer to the ordinary GNU General Public License, version 2, instead of to this License. (If a newer version than version 2 of the ordinary GNU General Public License has appeared, then you can specify that version instead if you wish.) Do not make any other change in these notices.

Once this change is made in a given copy, it is irreversible for that copy, so the ordinary GNU General Public License applies to all subsequent copies and derivative works made from that copy.

This option is useful when you wish to copy part of the code of the Library into a program that is not a library.

4. You may copy and distribute the Library (or a portion or derivative of it, under Section 2) in object code or executable form under the terms of Sections 1 and 2 above provided that you accompany it with the complete corresponding machine-readable source code, which must be distributed under the terms of Sections 1 and 2 above on a medium customarily used for software interchange.

If distribution of object code is made by offering access to copy from a designated place, then offering equivalent access to copy the source code from the same place satisfies the requirement to distribute the source code, even though third parties are not compelled to copy the source along with the object code.

5. A program that contains no derivative of any portion of the Library, but is designed to work with the Library by being compiled or linked with it, is called a "work that uses the Library". Such a work, in isolation, is not a derivative work of the Library, and therefore falls outside the scope of this License.

However, linking a "work that uses the Library" with the Library creates an executable that is a derivative of the Library (because it contains portions of the Library), rather than a "work that uses the library". The executable is therefore covered by this License. Section 6 states terms for distribution of such executables.

When a "work that uses the Library" uses material from a header file that is part of the Library, the object code for the work may be a

derivative work of the Library even though the source code is not. Whether this is true is especially significant if the work can be linked without the Library, or if the work is itself a library. The threshold for this to be true is not precisely defined by law.

If such an object file uses only numerical parameters, data structure layouts and accessors, and small macros and small inline functions (ten lines or less in length), then the use of the object file is unrestricted, regardless of whether it is legally a derivative work. (Executables containing this object code plus portions of the Library will still fall under Section 6.)

Otherwise, if the work is a derivative of the Library, you may distribute the object code for the work under the terms of Section 6. Any executables containing that work also fall under Section 6, whether or not they are linked directly with the Library itself.

6. As an exception to the Sections above, you may also combine or link a “work that uses the Library” with the Library to produce a work containing portions of the Library, and distribute that work under terms of your choice, provided that the terms permit modification of the work for the customer’s own use and reverse engineering for debugging such modifications.

You must give prominent notice with each copy of the work that the Library is used in it and that the Library and its use are covered by this License. You must supply a copy of this License. If the work during execution displays copyright notices, you must include the copyright notice for the Library among them, as well as a reference directing the user to the copy of this License. Also, you must do one of these things:

- a) Accompany the work with the complete corresponding machine-readable source code for the Library including whatever changes were used in the work (which must be distributed under Sections 1 and 2 above); and, if the work is an executable linked with the Library, with the complete machine-readable “work that uses the Library”, as object code and/or source code, so that the user can modify the Library and then relink to produce a modified executable containing the modified Library. (It is understood that the user who changes the contents of definitions files in the Library will not necessarily be able to recompile the application to use the modified definitions.)
- b) Use a suitable shared library mechanism for linking with the Library. A suitable mechanism is one that (1) uses at run time a copy of the library already present on the user’s computer system, rather than copying library functions into the executable, and (2) will operate properly with a modified version of the library, if the user installs one, as long as the modified version is interface-compatible with the version that the work was made with.
- c) Accompany the work with a written offer, valid for at least three years, to give the same user the materials specified in Subsection 6a, above, for a charge no more than the cost of performing this distribution.
- d) If distribution of the work is made by offering access to copy from a designated place, offer equivalent access to copy the above specified materials from the same place.
- e) Verify that the user has already received a copy of these materials or that you have already sent this user a copy.

For an executable, the required form of the “work that uses the Library” must include any data and utility programs needed for reproducing the executable from it. However, as a special exception, the materials to be distributed need not include anything that is normally distributed (in either source or binary form) with the major components (compiler, kernel, and so on) of the operating system on which the executable runs, unless that component itself accompanies the executable.

It may happen that this requirement contradicts the license restrictions of other proprietary libraries that do not normally accompany the operating system. Such a contradiction means you cannot use both them and the Library together in an executable that you distribute.

7. You may place library facilities that are a work based on the Library side-by-side in a single library together with other library facilities not covered by this License, and distribute such a combined library, provided that the separate distribution of the work based on the Library and of the other library facilities is otherwise permitted, and provided that you do these two things:

- a) Accompany the combined library with a copy of the same work based on the Library, uncombined with any other library facilities. This must be distributed under the terms of the Sections above.
- b) Give prominent notice with the combined library of the fact that part of it is a work based on the Library, and explaining where to find the accompanying uncombined form of the same work.

8. You may not copy, modify, sublicense, link with, or distribute the Library except as expressly provided under this License. Any attempt otherwise to copy, modify, sublicense, link with, or distribute the Library is void, and will automatically terminate your rights under this License. However, parties who have received copies, or rights, from you under this License will not have their licenses terminated so long as such parties remain in full compliance.

9. You are not required to accept this License, since you have not signed it. However, nothing else grants you permission to modify or distribute the Library or its derivative works. These actions are prohibited by law if you do not accept this License. Therefore, by modifying or distributing the Library (or any work based on the Library), you indicate your acceptance of this License to do so, and all its terms and conditions for copying, distributing or modifying the Library or works based on it.

10. Each time you redistribute the Library (or any work based on the Library), the recipient automatically receives a license from the original licensor to copy, distribute, link with or modify the Library subject to these terms and conditions. You may not impose any further restrictions on the recipients’ exercise of the rights granted herein. You are not responsible for enforcing compliance by third parties with this License.

11. If, as a consequence of a court judgment or allegation of patent infringement or for any other reason (not limited to patent issues), conditions are imposed on you (whether by court order, agreement or otherwise) that contradict the conditions of this License, they do not excuse you from the conditions of this License. If you cannot distribute so as to satisfy simultaneously your obligations under this License and any other pertinent obligations, then as a consequence you may not distribute the Library at all. For example, if a patent license would not permit royalty-free redistribution of the Library by all those who receive copies directly or indirectly through you, then the only way you could satisfy both it and this License would be to refrain entirely from distribution of the Library.

If any portion of this section is held invalid or unenforceable under any particular circumstance, the balance of the section is intended to apply, and the section as a whole is intended to apply in other circumstances.

It is not the purpose of this section to induce you to infringe any patents or other property right claims or to contest validity of any such claims; this section has the sole purpose of protecting the integrity of the free software distribution system which is implemented by public license practices. Many people have made generous contributions to the wide range of software distributed through that system in reliance on consistent application of that system; it is up to the author/donor to decide if he or she is willing to distribute software through any other

system and a licensee cannot impose that choice.

This section is intended to make thoroughly clear what is believed to be a consequence of the rest of this License.

12. If the distribution and/or use of the Library is restricted in certain countries either by patents or by copyrighted interfaces, the original copyright holder who places the Library under this License may add an explicit geographical distribution limitation excluding those countries, so that distribution is permitted only in or among countries not thus excluded. In such case, this License incorporates the limitation as if written in the body of this License.

13. The Free Software Foundation may publish revised and/or new versions of the Lesser General Public License from time to time. Such new versions will be similar in spirit to the present version, but may differ in detail to address new problems or concerns.

Each version is given a distinguishing version number. If the Library specifies a version number of this License which applies to it and “any later version”, you have the option of following the terms and conditions either of that version or of any later version published by the Free Software Foundation. If the Library does not specify a license version number, you may choose any version ever published by the Free Software Foundation.

14. If you wish to incorporate parts of the Library into other free programs whose distribution conditions are incompatible with these, write to the author to ask for permission. For software which is copyrighted by the Free Software Foundation, write to the Free Software Foundation; we sometimes make exceptions for this. Our decision will be guided by the two goals of preserving the free status of all derivatives of our free software and of promoting the sharing and reuse of software generally.

NO WARRANTY

15. BECAUSE THE LIBRARY IS LICENSED FREE OF CHARGE, THERE IS NO WARRANTY FOR THE LIBRARY, TO THE EXTENT PERMITTED BY APPLICABLE LAW. EXCEPT WHEN OTHERWISE STATED IN WRITING THE COPYRIGHT HOLDERS AND/OR OTHER PARTIES PROVIDE THE LIBRARY “AS IS” WITHOUT WARRANTY OF ANY KIND, EITHER EXPRESSED OR IMPLIED, INCLUDING, BUT NOT LIMITED TO, THE IMPLIED WARRANTIES OF MERCHANTABILITY AND FITNESS FOR A PARTICULAR PURPOSE. THE ENTIRE RISK AS TO THE QUALITY AND PERFORMANCE OF THE LIBRARY IS WITH YOU. SHOULD THE LIBRARY PROVE DEFECTIVE, YOU ASSUME THE COST OF ALL NECESSARY SERVICING, REPAIR OR CORRECTION.

16. IN NO EVENT UNLESS REQUIRED BY APPLICABLE LAW OR AGREED TO IN WRITING WILL ANY COPYRIGHT HOLDER, OR ANY OTHER PARTY WHO MAY MODIFY AND/OR REDISTRIBUTE THE LIBRARY AS PERMITTED ABOVE, BE LIABLE TO YOU FOR DAMAGES, INCLUDING ANY GENERAL, SPECIAL, INCIDENTAL OR CONSEQUENTIAL DAMAGES ARISING OUT OF THE USE OR INABILITY TO USE THE LIBRARY (INCLUDING BUT NOT LIMITED TO LOSS OF DATA OR DATA BEING RENDERED INACCURATE OR LOSSES

SUSTAINED BY YOU OR THIRD PARTIES OR A FAILURE OF THE LIBRARY TO OPERATE WITH ANY OTHER SOFTWARE), EVEN IF SUCH HOLDER OR OTHER PARTY HAS BEEN ADVISED OF THE POSSIBILITY OF SUCH DAMAGES.

END OF TERMS AND CONDITIONS

How to Apply These Terms to Your New Libraries

If you develop a new library, and you want it to be of the greatest possible use to the public, we recommend making it free software that everyone can redistribute and change. You can do so by permitting redistribution under these terms (or, alternatively, under the terms of the ordinary General Public License).

To apply these terms, attach the following notices to the library. It is safest to attach them to the start of each source file to most effectively convey the exclusion of warranty; and each file should have at least the “copyright” line and a pointer to where the full notice is found.

```
<one line to give the library's name and an idea of what it does.>  
Copyright (C) <year> <name of author>
```

This library is free software; you can redistribute it and/or modify it under the terms of the GNU Lesser General Public License as published by the Free Software Foundation; either version 2.1 of the License, or (at your option) any later version.

This library is distributed in the hope that it will be useful, but WITHOUT ANY WARRANTY; without even the implied warranty of MERCHANTABILITY or FITNESS FOR A PARTICULAR PURPOSE. See the GNU Lesser General Public License for more details.

You should have received a copy of the GNU Lesser General Public License along with this library; if not, write to the Free Software Foundation, Inc., 59 Temple Place, Suite 330, Boston, MA 02111-1307 USA

Also add information on how to contact you by electronic and paper mail.

You should also get your employer (if you work as a programmer) or your school, if any, to sign a “copyright disclaimer” for the library, if necessary. Here is a sample; alter the names:

```
Yoyodyne, Inc., hereby disclaims all copyright interest in the  
library 'Frob' (a library for tweaking knobs) written by James  
Random Hacker.
```

```
<signature of Ty Coon>, 1 April 1990  
Ty Coon, President of Vice
```

That's all there is to it!

Index

1080i.....	18, 23
480i	18, 23
480p	18, 23
720p	18, 23

A

Antenna A, B terminal	13
ASPECT button	11, 40
ATSC	9
Auto shut off	39

B

BBE	55
Blocking Message	64

C

Card Menu Screen	87
CC	9, 66
Channel up / down buttons (Unit).....	12, 34
CH buttons (Remote Control)	11, 34
Component signal input 1-3 terminals	13

D

DCF	9, 86
DCM	9, 16
DCM INTERFACE (POD INTERFACE)	13
DIGITAL AUDIO OUT terminal	13
Dolby Digital	9, 21
DTV	9, 35

E

EAS	8, 9
-----------	------

F

Freezing pictures	42
-------------------------	----

H

HDMI input terminal	13, 24
HDMI position	37
HDTV	9

I

ID1	77
Input 1, 2, 3 terminals	13

J

JPEG	9, 86
------------	-------

L

LAMP indicator	12
Left screen	46
Light button	11

M

Main screen	44
MCAA	9, 59
MSO	8, 9
MUTE button	11

N

NTSC	9
Number keys	11, 35

O

OK button	11
-----------------	----

P

Password	9, 56
PCM	9, 21, 25
PC Card	87
PIP screen	44
POWER button (Remote Control)	11, 26, 34
POWER button / POWER indicator (Unit)	12, 26, 34

R

R-TUNE button	11, 36
RECALL button	11, 38
Receivable Broadcast Types	43
Remote Control Sensor	12, 34
Reset User's Memory Functions	64
RGB 1, 2 positions	37
RGB cable	22
RGB Input 1, 2 terminals	13
Right screen	46

S

SAP button	11, 42
SD Card	87
Sound mute	42
SVGA	23

T

TEMP indicator	12, 99
TV/VIDEO button	11, 37

U

Using stereo system	20
Using VCR	17, 19

V

VESA	23
VGA	23
Volume +/- buttons (Unit)	12, 34
VOL buttons (Remote Control)	11, 34

X

XGA	23
-----------	----

Y

Y, P _B , P _R	18
--	----

Customer' Record

The serial number of this product can be found on its back cover. You should note this serial number in the space provided below and retain this book, plus your purchase receipt, as a permanent record of your purchase to aid in identification in the event of theft or loss, and for Warranty Service purposes.

Model Number

Serial Number

Panasonic Consumer Electronics Company, Division of Matsushita Electric Corporation of America
One Panasonic Way Secaucus New Jersey 07094

Panasonic Sales Company, Division of Matsushita Electric of Puerto Rico Inc. ("PSC")
Ave. 65 de Infanteria, Km 9.5 San Gabriel Industrial Park, Carolina, Puerto Rico 00985